

HVAC

Die No.: 6941

Wt.: 0.375-0.400 (KG/M)

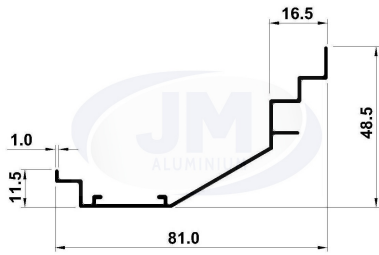

Die No.: 38621

Wt.: 0.216-0.259 (KG/M)

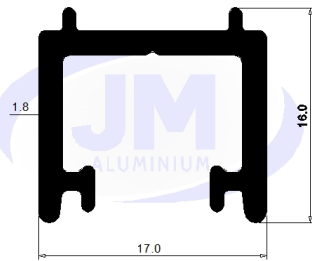

Die No.: 38634

Wt.: 0.349-0.438 (KG/M)

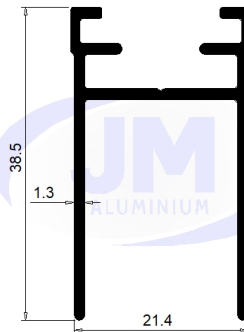

Die No.: 37191

Wt.: 0.115-0.142 (KG/M)

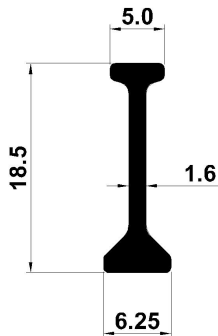

A.C. Grill, Louvers & Dampers

Die No.: 36141

Wt.: 0.035-0.045 (KG/M)



Die No.: 38623

Wt.: 0.323-0.415 (KG/M)

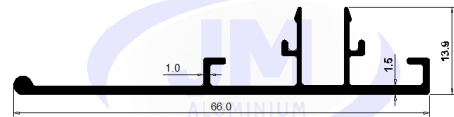

Die No.: 38637

Wt.: 0.338-0.403 (KG/M)

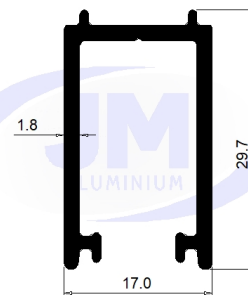

Die No.: 37192

Wt.: 0.090-0.135 (KG/M)

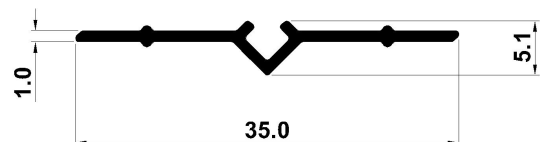

HVAC

Die No.: 37199

Wt.: 0.213-0.290 (KG/M)

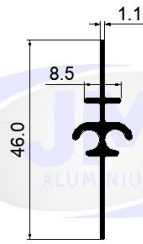

Die No.: 6504

Wt.: 0.580 - 0.680 (KG/M)

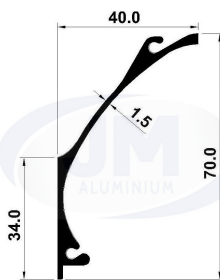

Die No.: 6786

Wt.: 0.700-0.820 (KG/M)

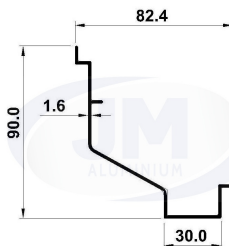

Die No.: 6524

Wt.: 1.340-1.400 (KG/M)

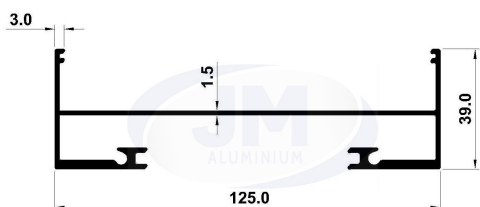

A.C. Grill, Louvers & Dampers

Die No.: 37214

Wt.: 0.170-0.256 (KG/M)

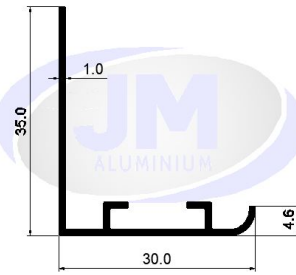

Die No.: 36006

Wt.: 0.265 - 0.315 (KG/M)

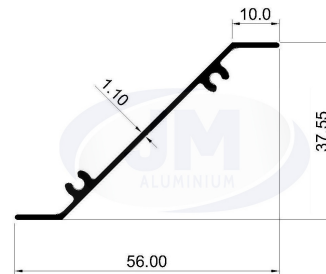

Die No.: 6793

Wt.: 0.090-0.140 (KG/M)

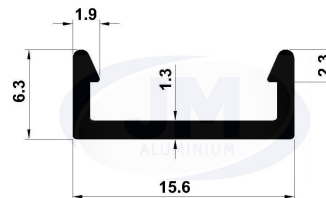

Die No.: 6602

Wt.: 0.070-0.090 (KG/M)



HVAC

Die No.: 6604

Wt.: 0.080-0.120 (KG/M)

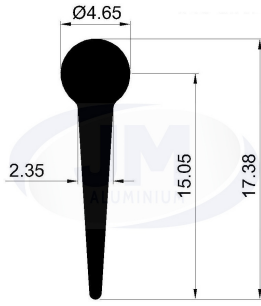

Die No.: 6617

Wt.: 0.080 - 0.120 (KG/M)

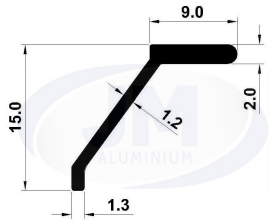

Die No.: 6620

Wt.: 0.235 - 0.265 (KG/M)

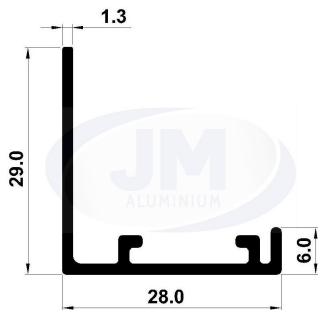

Die No.: 6623

Wt.: 0.300 - 0.360 (KG/M)

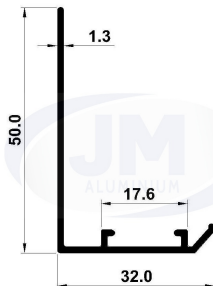

A.C. Grill, Louvers & Dampers

Die No.: 6607

Wt.: 0.250-0.340 (KG/M)

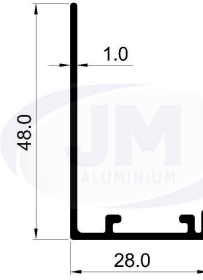

Die No.: 6618

Wt.: 0.300 - 0.330 (KG/M)

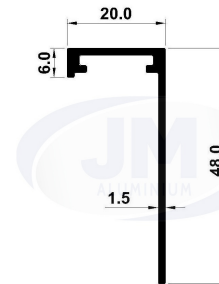

Die No.: 6622

Wt.: 0.230 - 0.280 (KG/M)

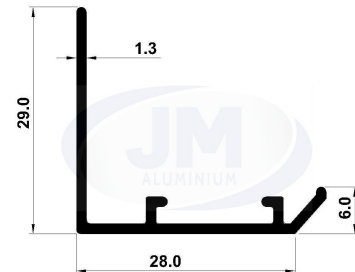

Die No.: 6848

Wt.: 0.965-0.995 (KG/M)

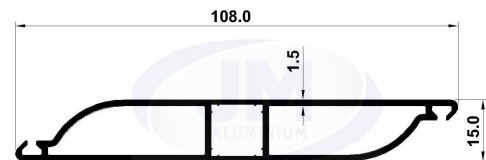

HVAC

A.C. Grill, Louvers & Dampers

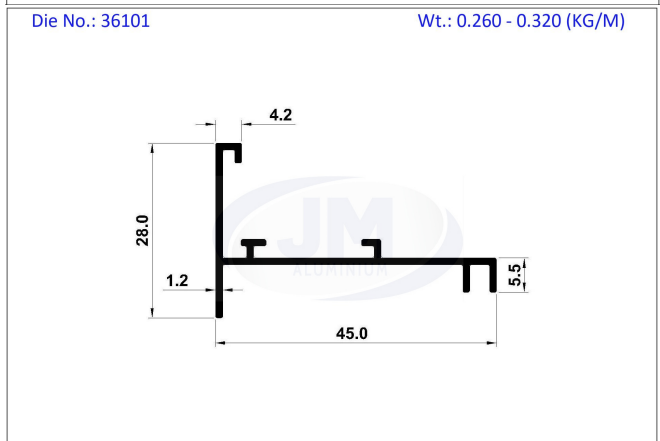
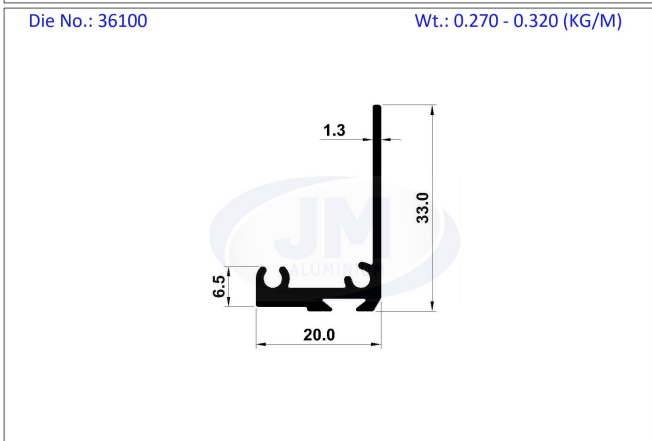
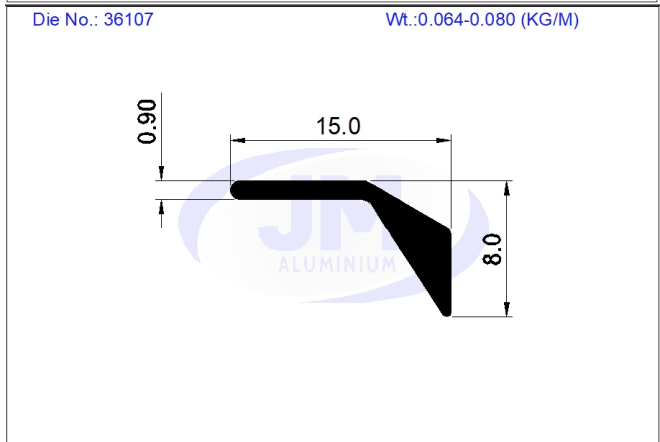
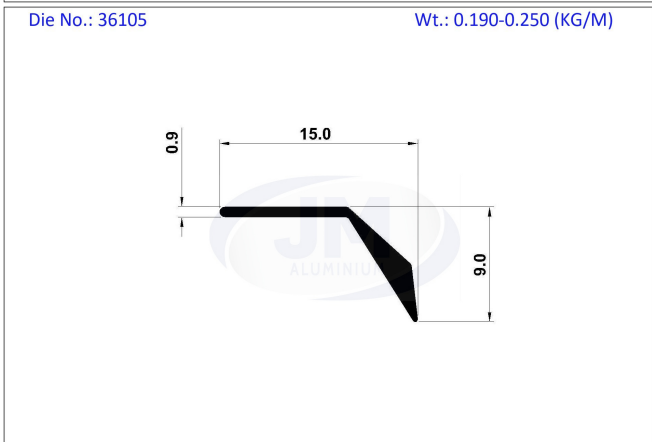
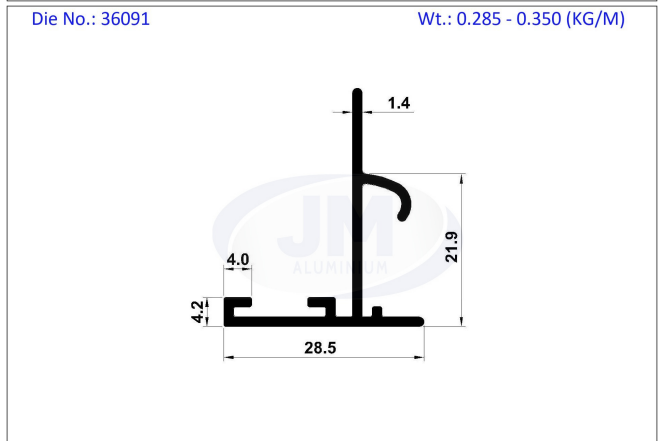
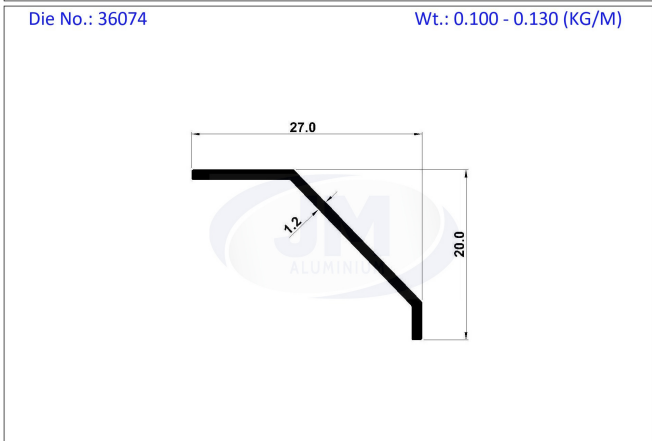
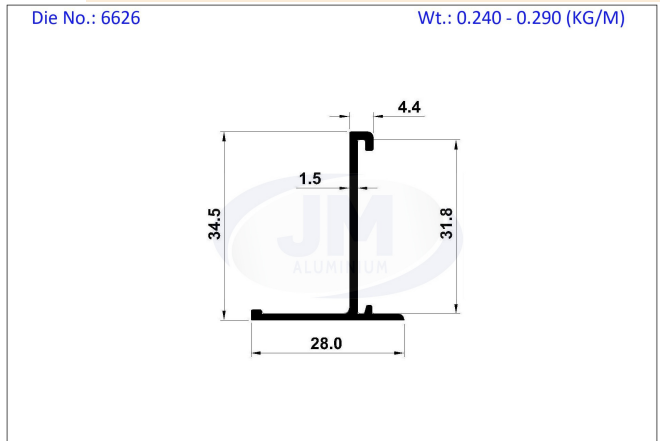
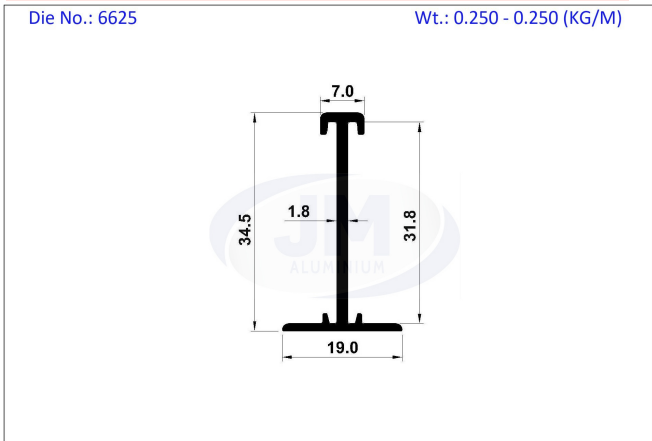

HVAC

Die No.: 36117

Wt.: 0.140-0.170 (KG/M)

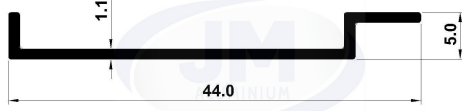

Die No.: 36094

Wt.: 0.730 - 0.850 (KG/M)

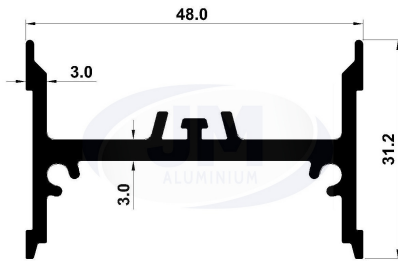

Die No.: 36097

Wt.: 0.095 - 0.117 (KG/M)

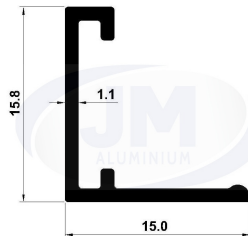

Die No.: 36070

Wt.: 0.085 - 0.100 (KG/M)

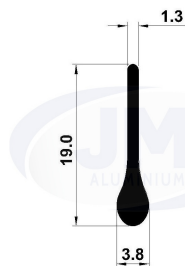

A.C. Grill, Louvers & Dampers

Die No.: 36123

Wt.: 0.400 - 0.480 (KG/M)

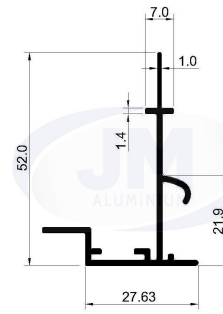

Die No.: 36095

Wt.: 0.100-0.130 (KG/M)

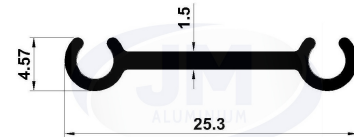

Die No.: 6718

Wt.: 0.205 - 0.235 (KG/M)

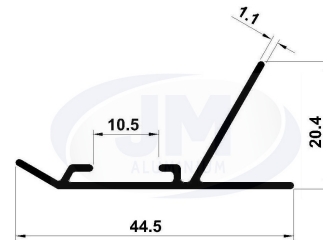

Die No.: 36072

Wt.: 0.200 - 0.240 (KG/M)

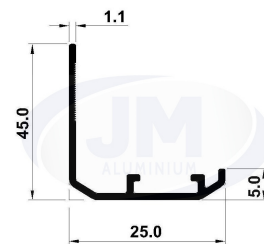

HVAC

Die No.: 36071

Wt.: 0.145 - 0.185 (KG/M)

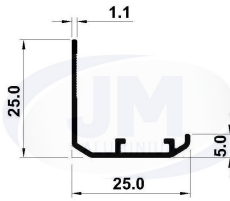

Die No.: 36075

Wt.: 0.180 - 0.230 (KG/M)

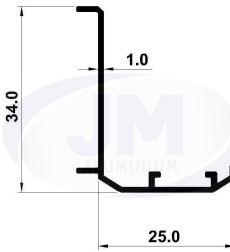

Die No.: 37145

Wt.: 0.201-0.246 (KG/M)

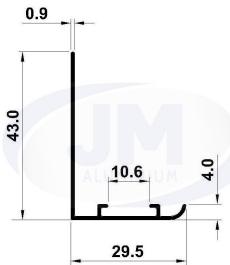

Die No.: 37143

Wt.: 0.208-0.248 (KG/M)

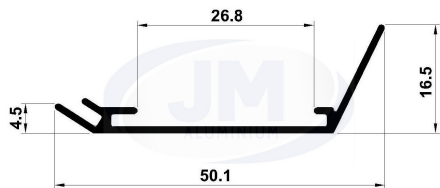

A.C. Grill, Louvers & Dampers

Die No.: 36073

Wt.: 0.120 - 0.160 (KG/M)

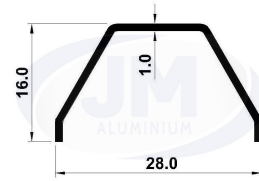

Die No.: 6959

Wt.: 0.090-0.120 (KG/M)

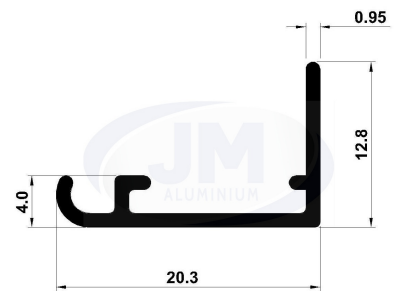

Die No.: 37149

Wt.: 0.052-0.061 (KG/M)

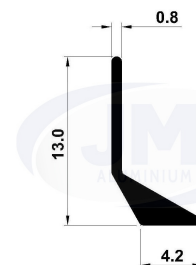

Die No.: 37144

Wt.: 0.078-0.097 (KG/M)

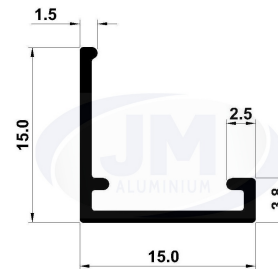

HVAC

Die No.: 36178

Wt.: 0.077-0.105 (KG/M)

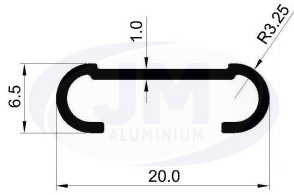

A.C. Grill, Louvers & Dampers

Die No.: 36179

Wt.: 0.095-0.121 (KG/M)

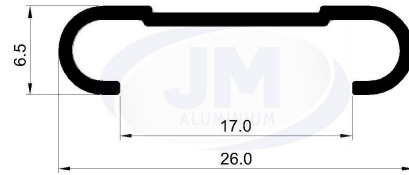

Die No.: 37146

Wt.: 0.048-0.057 (KG/M)

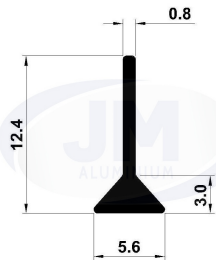

Die No.: 37148

Wt.: 0.052-0.061 (KG/M)

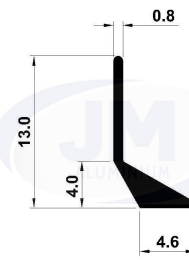

Die No.: 36049

Wt.: 0.700 - 0.820 (KG/M)

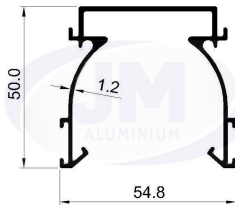

Die No.: 6823

Wt.: 0.120-0.150 (KG/M)

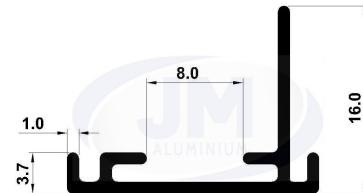

Die No.: 6955

Wt.: 0.220-0.250 (KG/M)

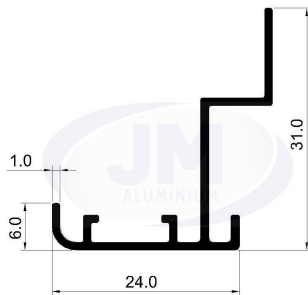

Die No.: 36181

Wt.: 0.235-0.287 (KG/M)

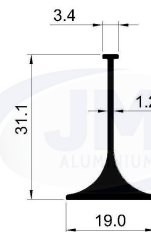

HVAC

Die No.: 37189

Wt.: 0.140-0.178 (KG/M)

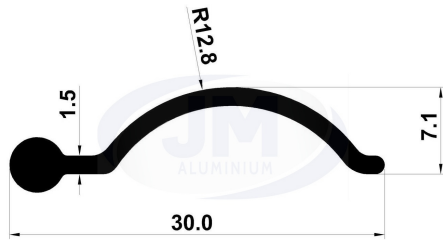

Die No.: 36146

Wt.: 0.400-0.480 (KG/M)

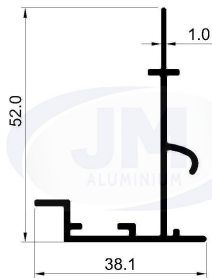

Die No.: 36137

Wt.: 0.230 - 0.280 (KG/M)

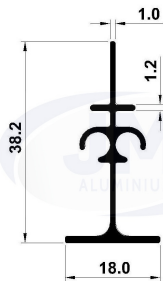

Die No.: 6840

Wt.: 0.215-0.245 (KG/M)

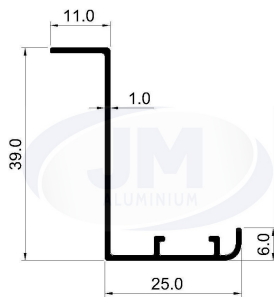

A.C. Grill, Louvers & Dampers

Die No.: 6998

Wt.: 0.395-0.450 (KG/M)

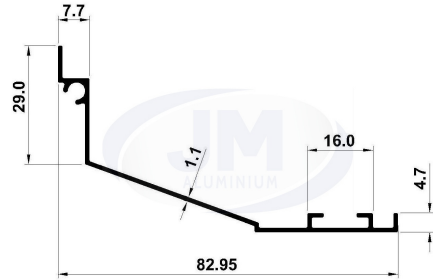

Die No.: 36142

Wt.: 0.300-0.350 (KG/M)

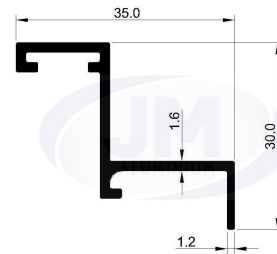

Die No.: 36139

Wt.: 0.190-0.240 (KG/M)

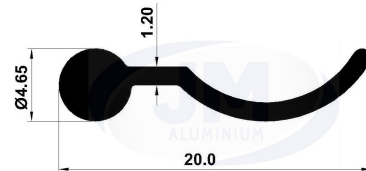

Die No.: 36211

Wt.: 0.176 - 0.224 (KG/M)

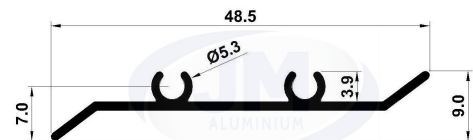

HVAC

Die No.: 36127

Wt.: 0.371-0.454 (KG/M)

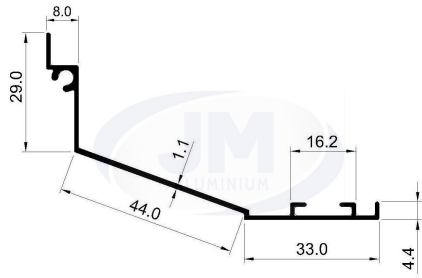

Die No.: 6603

Wt.: 0.250-0.300 (KG/M)

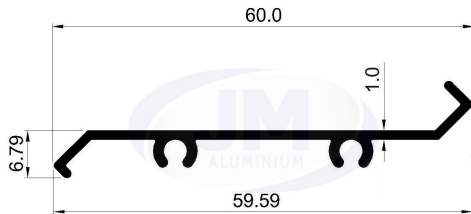

Die No.: 36183

Wt.: 0.336 - 0.410 (KG/M)

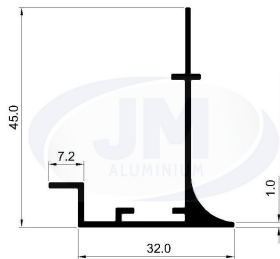

Die No.: 36184

Wt.: 0.286 - 0.350 (KG/M)

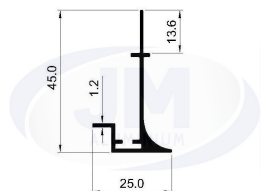

A.C. Grill, Louvers & Dampers

Die No.: 36209

Wt.: 0.066 - 0.089 (KG/M)

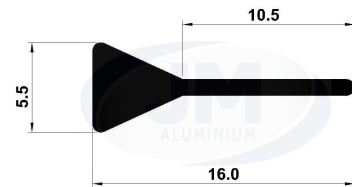

Die No.: 36205

Wt.: 0.163-0.207 (KG/M)

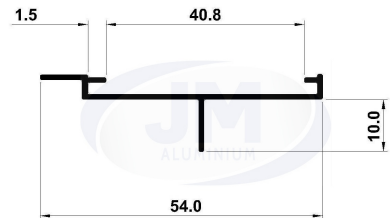

Die No.: 6790

Wt.: 1.020-1.100 (KG/M)

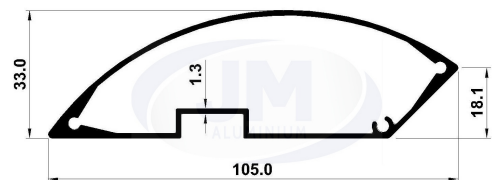

HVAC

Die No.: 36210

Wt.: 0.166 - 0.211 (KG/M)

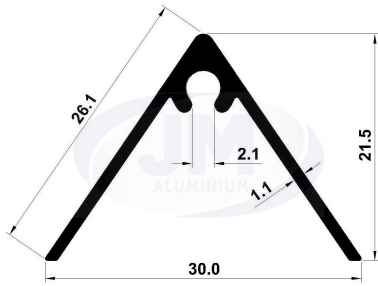

Die No.: 36190

Wt.: 0.054 - 0.073 (KG/M)

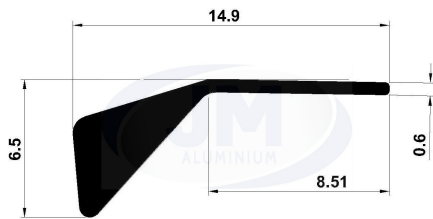

Die No.: 36175

Wt.: 0.88-0.113 (KG/M)



Die No.: 6521

Wt.: 0.060-0.090 (KG/M)

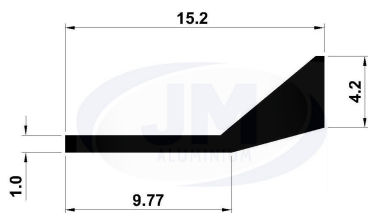

A.C. Grill, Louvers & Dampers

Die No.: 36157

Wt.: 0.070-0.100 (KG/M)

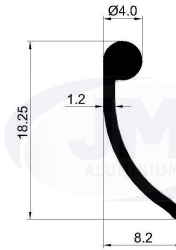

Die No.: 36203

Wt.: 0.132-0.168 (KG/M)

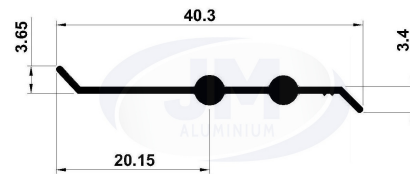

Die No.: 36177

Wt.: 0.078-0.106 (KG/M)

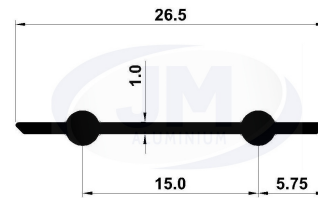

Die No.: 36126

Wt.: 0.180-0.230 (KG/M)



HVAC

Die No.: 36155

Wt.: 0.100-0.130 (KG/M)

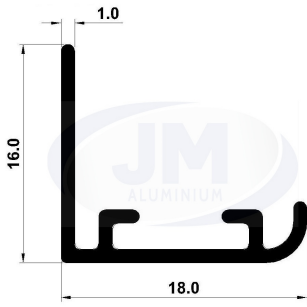

Die No.: 36108

Wt.: 0.350-0.440 (KG/M)

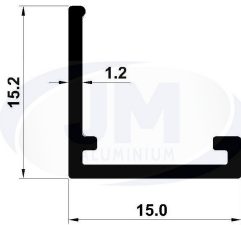

Die No.: 36173

Wt.: 0.290-0.355 (KG/M)

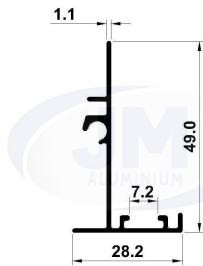

Die No.: 36220

Wt.: 0.118-0.167 (KG/M)

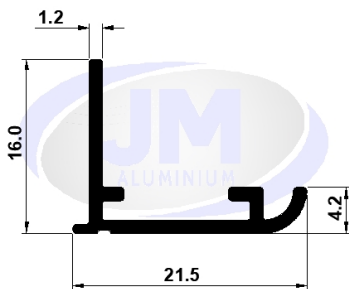

A.C. Grill, Louvers & Dampers

Die No.: 36218

Wt.: 0.061 - 0.082 (KG/M)

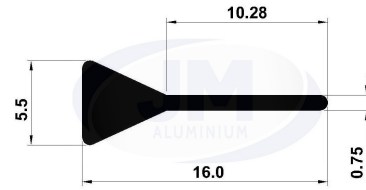

Die No.: 36145

Wt.: 0.270 - 0.330 (KG/M)

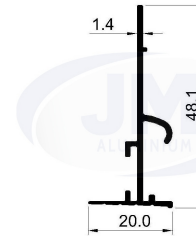

Die No.: 36174

Wt.: 0.286-0.350 (KG/M)

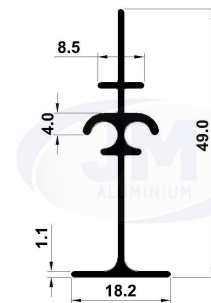

Die No.: 36152

Wt.: 0.298-0.485 (KG/M)

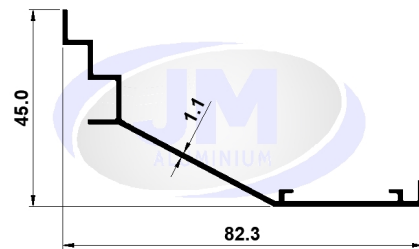

HVAC

Die No.: 37153

Wt.: 0.345-0.422 (KG/M)

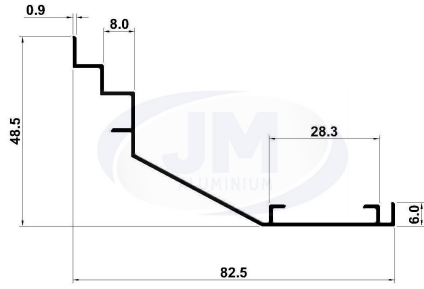

Die No.: 36215

Wt.: 0.164-0.209 (KG/M)

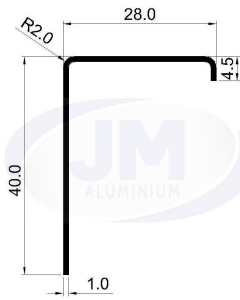

Die No.: 6970

Wt.: 0.190 - 0.240 (KG/M)

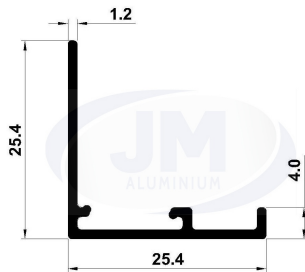

Die No.: 36232

Wt.: 0.320 - 0.400 (KG/M)

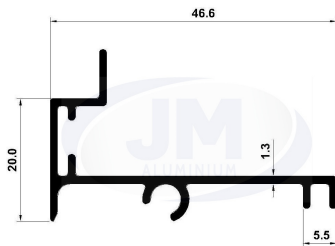

A.C. Grill, Louvers & Dampers

Die No.: 36180

Wt.: 0.300-0.401 (KG/M)

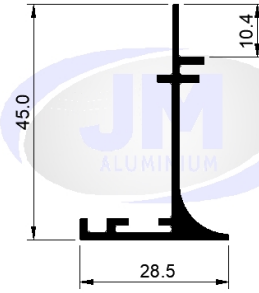

Die No.: 36213

Wt.: 0.068-0.093 (KG/M)

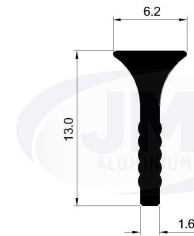

Die No.: 36191

Wt.: 0.394 - 0.482 (KG/M)

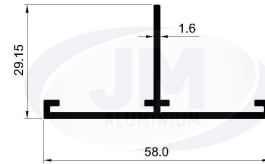

Die No.: 36005

Wt.: 0.265 - 0.310 (KG/M)

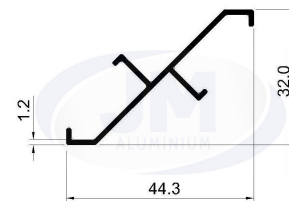

HVAC

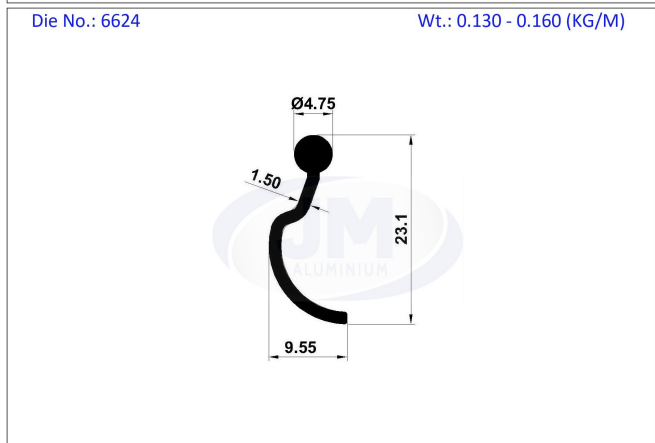
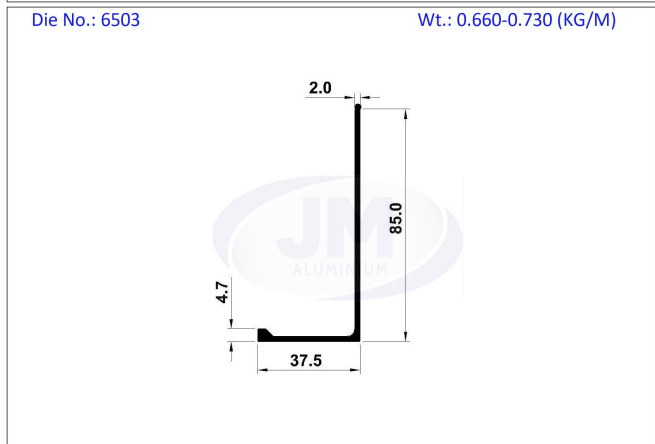
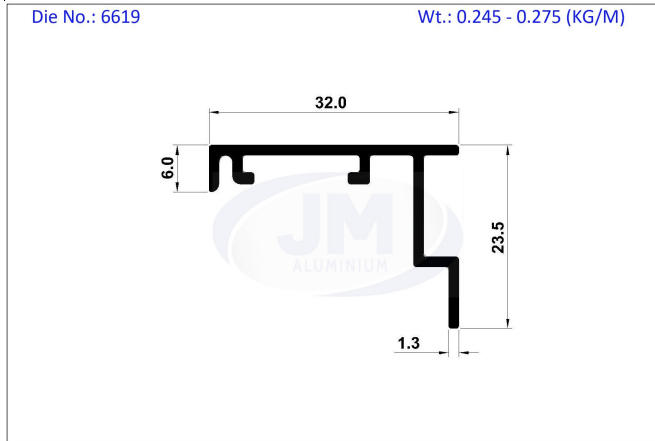
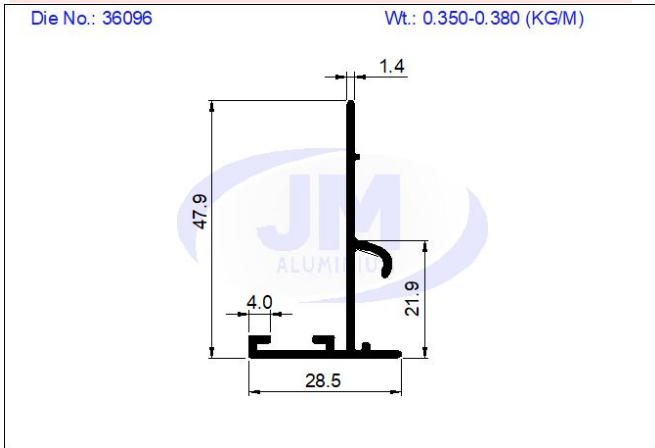

A.C. Grill, Louvers & Dampers

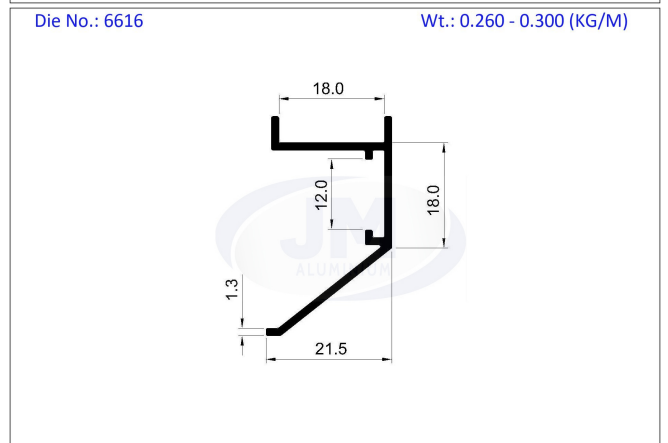
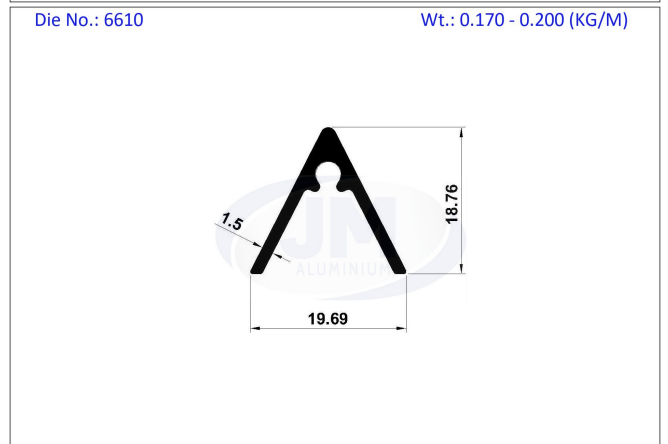
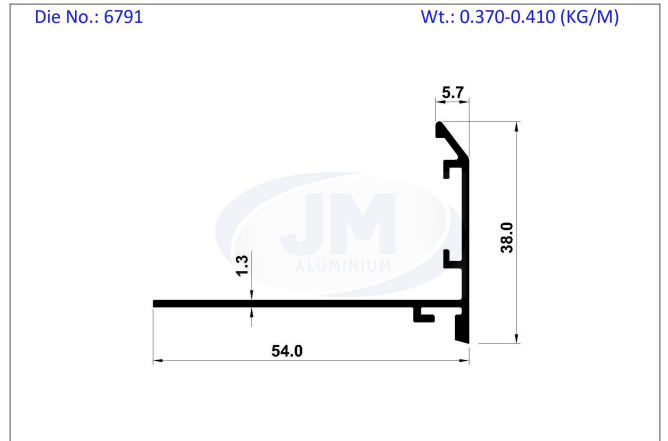
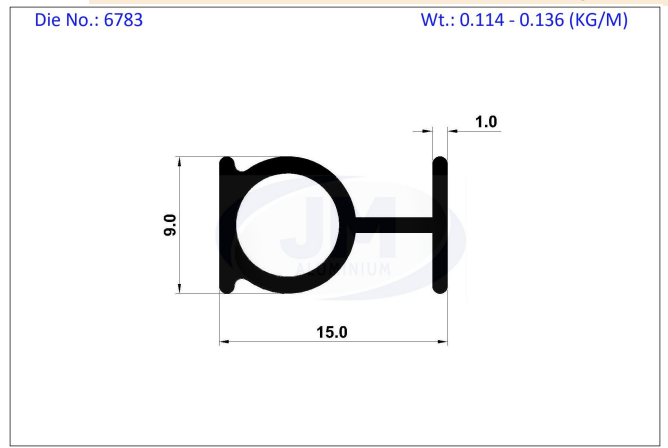

HVAC

Die No.: 35020

Wt.: 0.480 - 0.550 (KG/M)



Die No.: 36147

Wt.: 0.340 - 0.410 (KG/M)

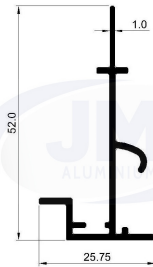

Die No.: 36182

Wt.: 0.336 - 0.410 (KG/M)

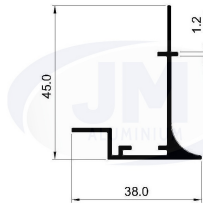

Die No.: 6980

Wt.: 0.120-0.155 (KG/M)

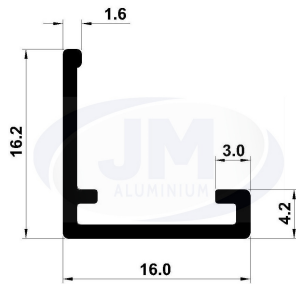

A.C. Grill, Louvers & Dampers

Die No.: 36092

Wt.: 0.255 - 0.310 (KG/M)

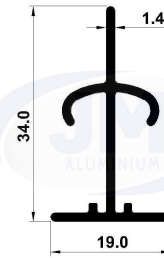

Die No.: 37147

Wt.: 0.052-0.061 (KG/M)

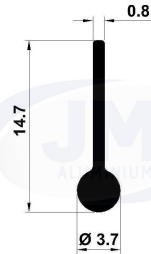

Die No.: 36221

Wt.: 0.123 - 0.157 (KG/M)

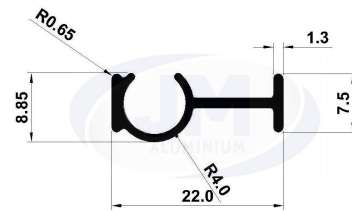

Die No.: 36114

Wt.: 0.150-0.190 (KG/M)

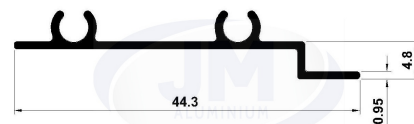

HVAC

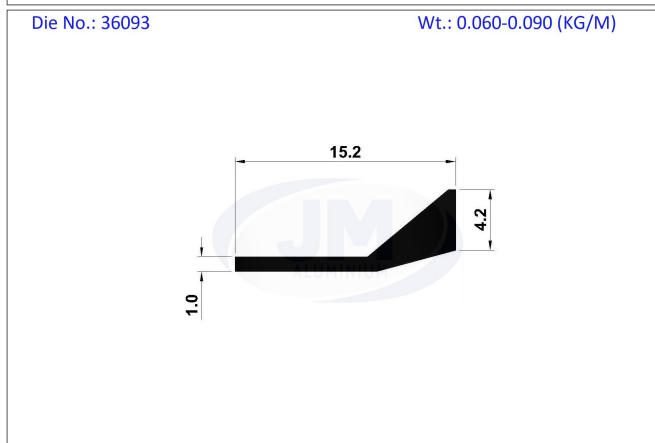
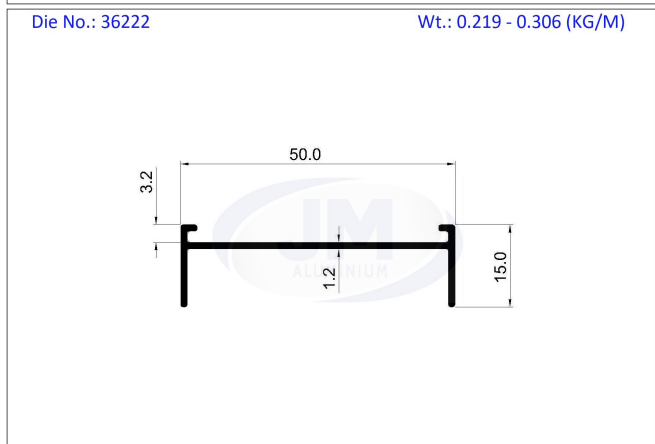
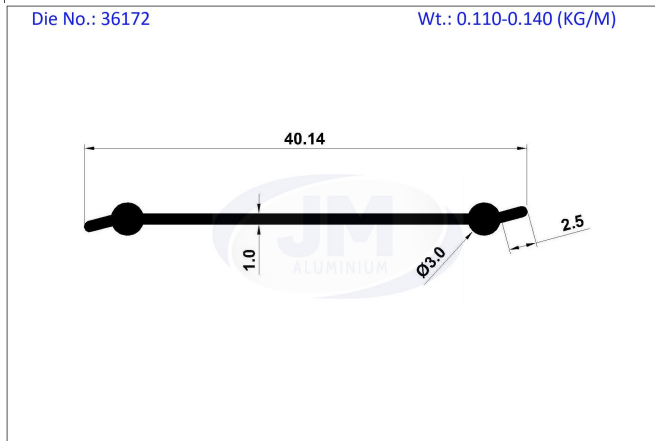
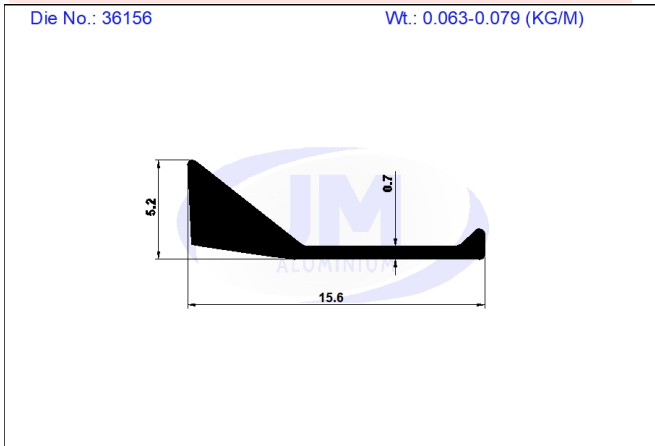

A.C. Grill, Louvers & Dampers

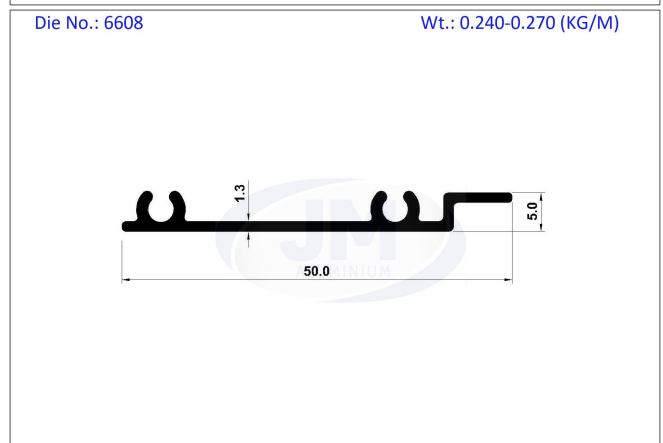
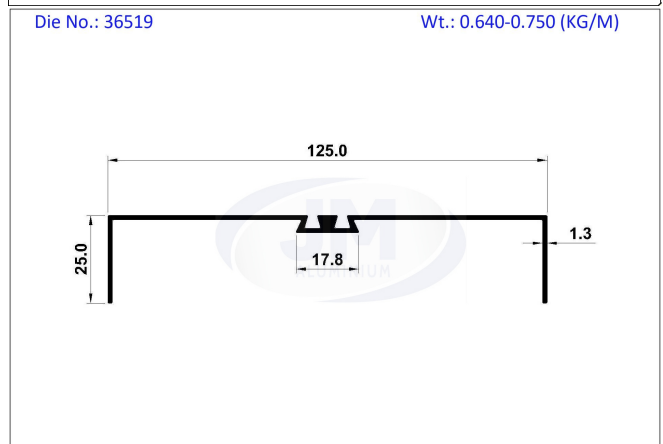
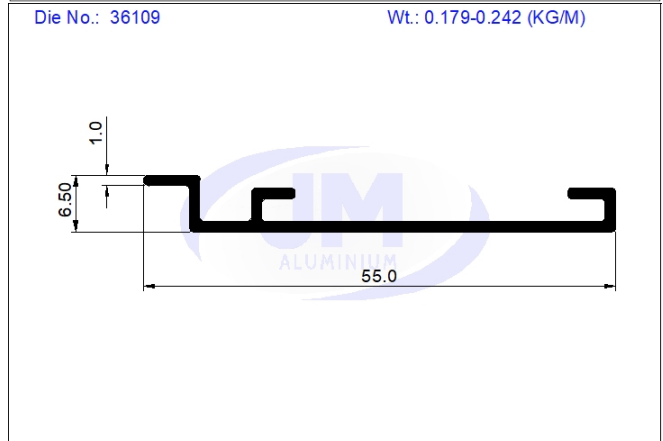
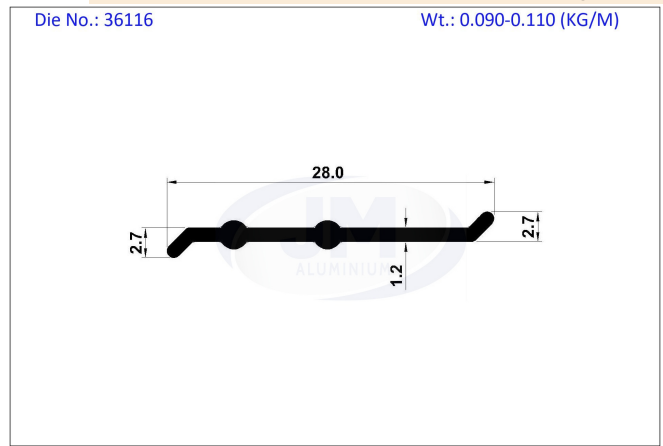

HVAC

Die No.: 36022

Wt.: 0.170 - 0.210 (KG/M)

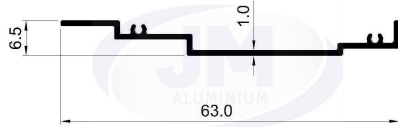

Die No.: 36228

Wt.: 0.809 - 0.931 (KG/M)

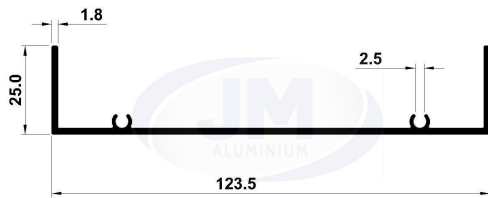

Die No.: 36098

Wt.: 0.140-0.170 (KG/M)

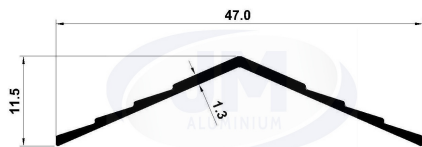

Die No.: 37142

Wt.: 0.295-0.354 (KG/M)

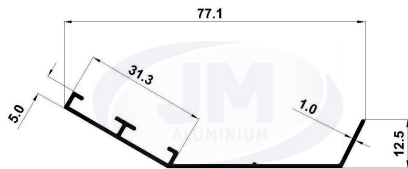

A.C. Grill, Louvers & Dampers

Die No.: 36085

Wt.: 0.190-0.230 (KG/M)

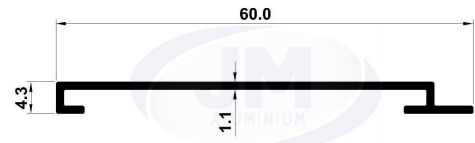

Die No.: 36176

Wt.: 0.163-0.208 (KG/M)

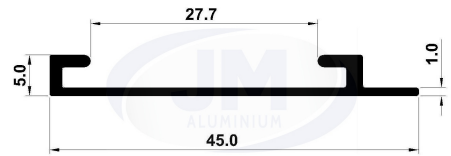

Die No.: 36104

Wt.: 0.060 - 0.075 (KG/M)



Die No.: 36125

Wt.: 0.070 - 0.090 (KG/M)



HVAC

Die No.: 36106

Wt.: 0.045-0.060 (KG/M)



Die No.: 36088

Wt.: 0.073-0.094 (KG/M)



Die No.: 6747

Wt.: 0.070-0.130 (KG/M)



Die No.: 36204

Wt.: 0.149-0.190 (KG/M)

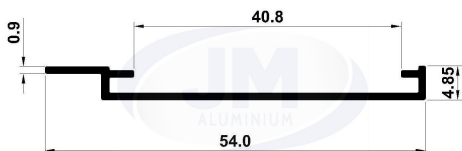

A.C. Grill, Louvers & Dampers

Die No.: 36518

Wt.: 0.576-0.836 (KG/M)

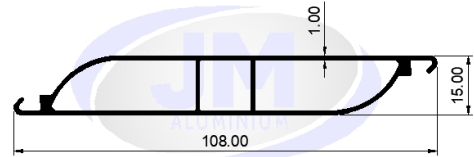

Die No.: 6534

Wt.: 0.230-0.270 (KG/M)

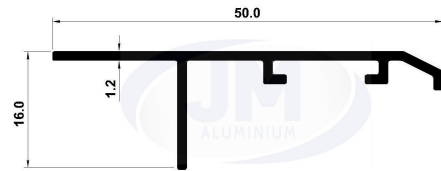

Die No.: 6601

Wt.: 0.130-0.170 (KG/M)



Die No.: 6792

Wt.: 0.420-0.480 (KG/M)

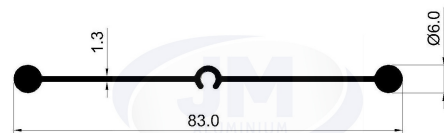

HVAC

Die No.: 6903

Wt.: 0.068-0.087 (KG/M)



Die No.: 6520

Wt.: 0.060-0.090 (KG/M)

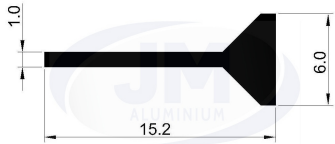

Die No.: 37215

Wt.: 0.083 - 0.125 (KG/M)

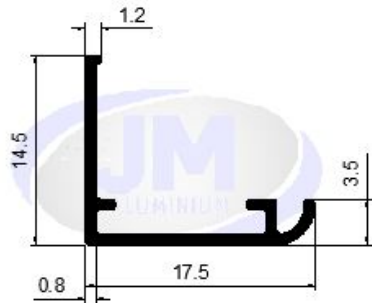

Die No.: 37216

Wt.: 0.071-0.090 (KG/M)

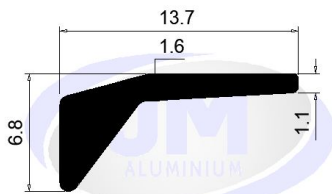

A.C. Grill, Louvers & Dampers

Die No.: 36208

Wt.: 0.060 - 0.110 (KG/M)

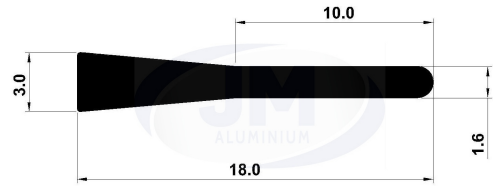

Die No.: 36219

Wt.: 0.062 - 0.084 (KG/M)

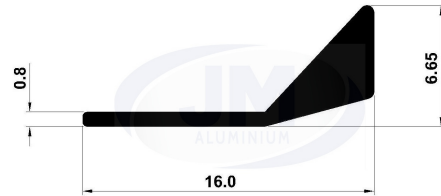

Die No.: 38368

Wt.: 0.406-0.542 (KG/M)

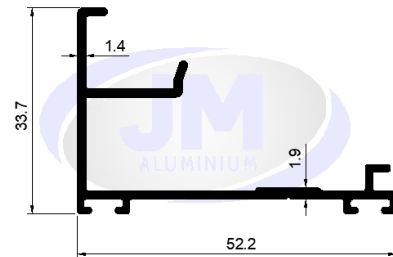

Die No.: 37259

Wt.: 0.279-0.391 (KG/M)

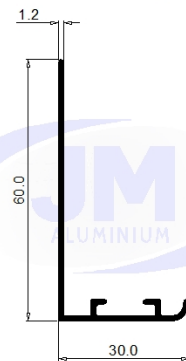

HVAC

Die No.: 37260

Wt.: 0.161-0.242 (KG/M)

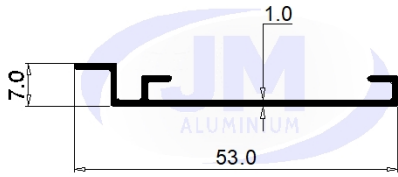

Die No.: 37265

Wt.: 0.061-0.077 (KG/M)

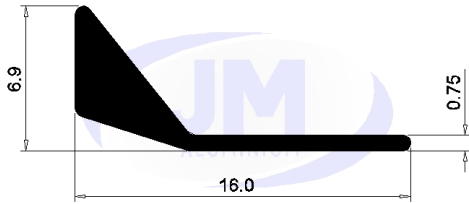

Die No.: 37267

Wt.: 0.070-0.088 (KG/M)

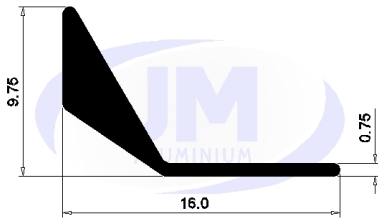

Die No.: 37269

Wt.: 0.189-0.229 (KG/M)

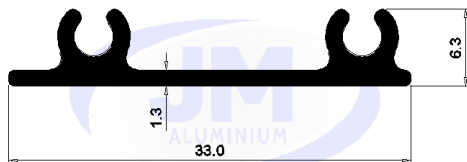

A.C. Grill, Louvers & Dampers

Die No.: 37261

Wt.: 0.086-0.128 (KG/M)

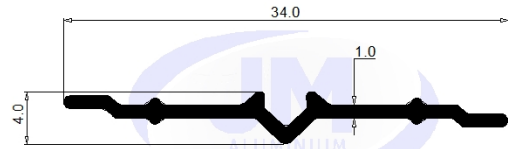

Die No.: 37266

Wt.: 0.054-0.070 (KG/M)

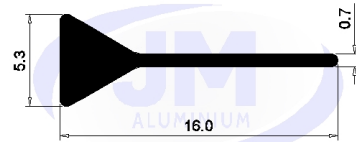

Die No.: 37268

Wt.: 0.087-0.121 (KG/M)

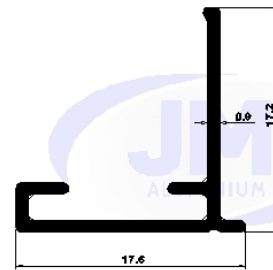

Die No.: 37270

Wt.: 0.101-0.129 (KG/M)

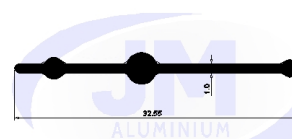

HVAC

Die No.: 37271

Wt.: 0.100-0.128 (KG/M)

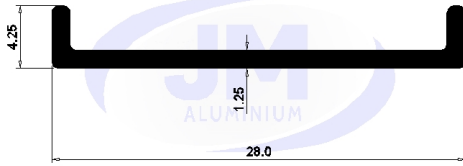

Die No.: 37273

Wt.: 0.309-0.416 (KG/M)

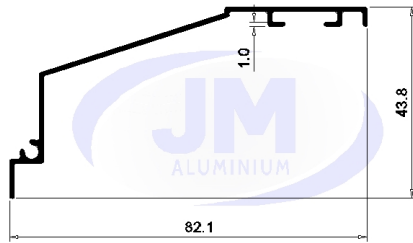

Die No.: 37275

Wt.: 0.220-0.298 (KG/M)

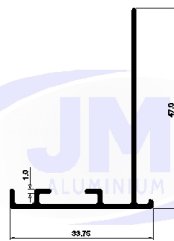

A.C. Grill, Louvers & Dampers

Die No.: 37272

Wt.: 0.150-0.190 (KG/M)

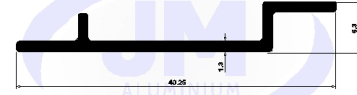

Die No.: 37274

Wt.: 0.398-0.591 (KG/M)

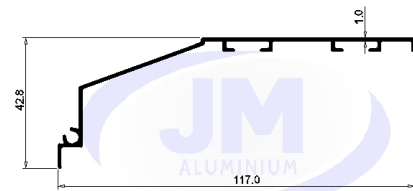

Die No.: 37276

Wt.: 0.187-0.253 (KG/M)

