

GEOMETRICAL SHAPES

L- Angle

Die No.: 45618

Wt.: 0.445 - 0.540 (KG/M)

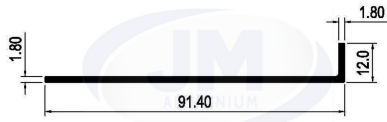

Die No.: 36026

Wt.: 0.135-0.165 (KG/M)

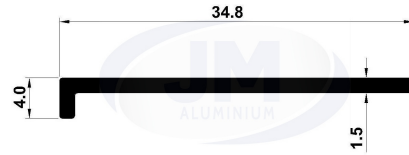

Die No.: 42031

Wt.: 0.552 - 0.712 (KG/M)

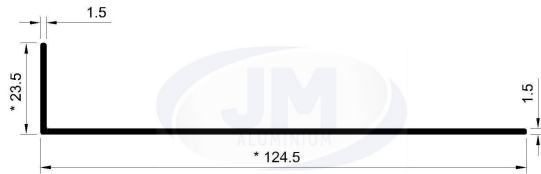

Die No.: 33448

Wt.: 0.060-0.080 (KG/M)



Die No.: 1757

Wt.: 2.050-2.150 (KG/M)

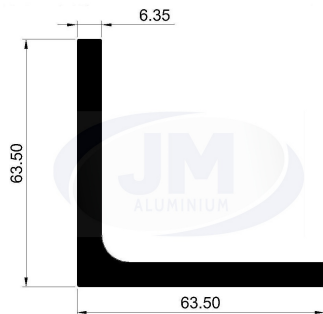

Die No.: 45621

Wt.: 0.350 - 0.410 (KG/M)

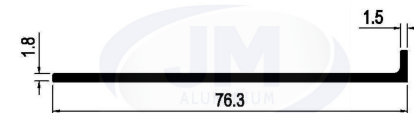

Die No.: 3306

Wt.: 0.345 (KG/M)

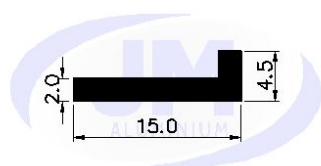

Die No.: 13046

Wt.: 0.045-0.060 (KG/M)

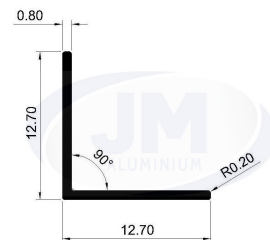

GEOMETRICAL SHAPES

L- Angle

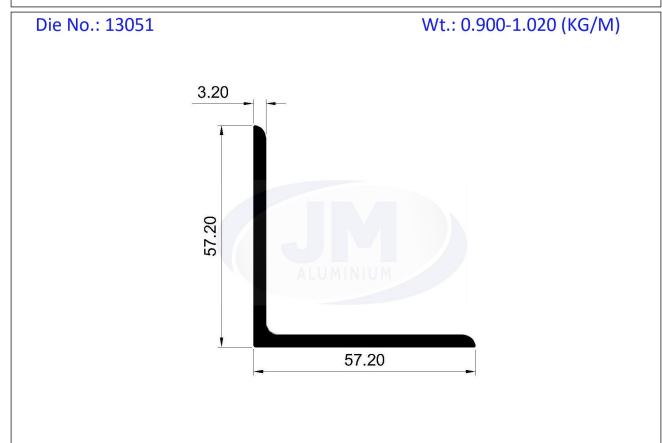
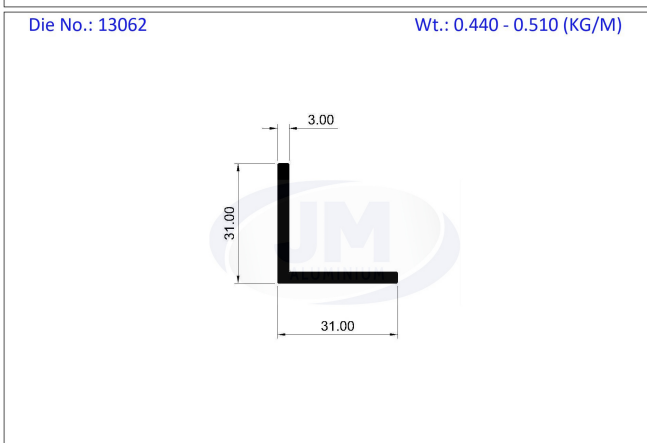
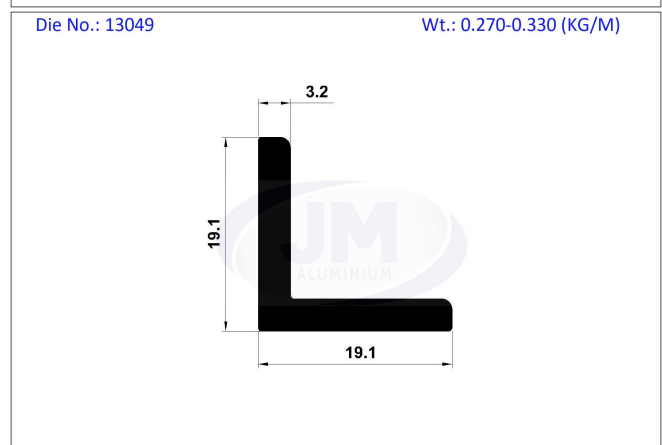
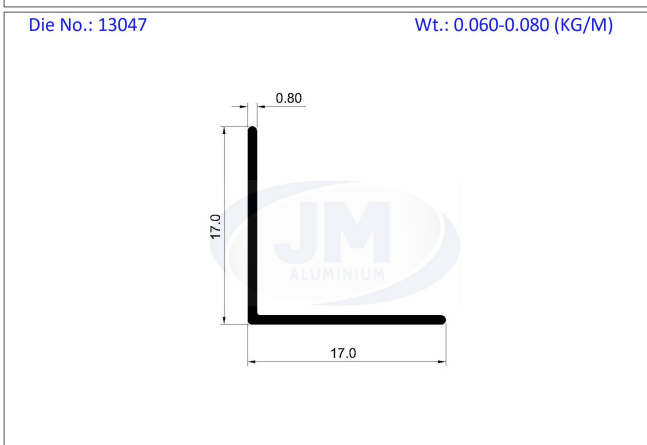
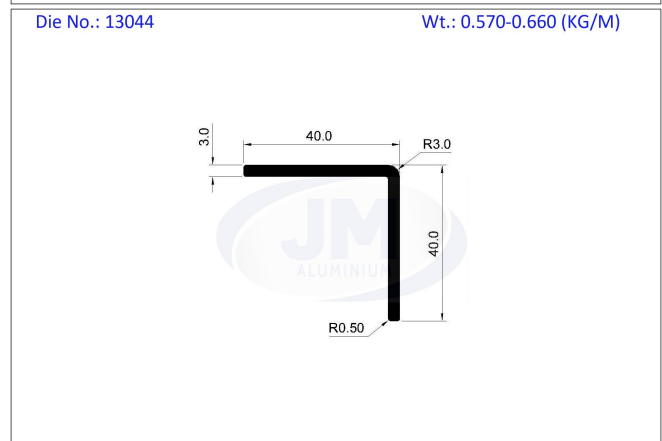
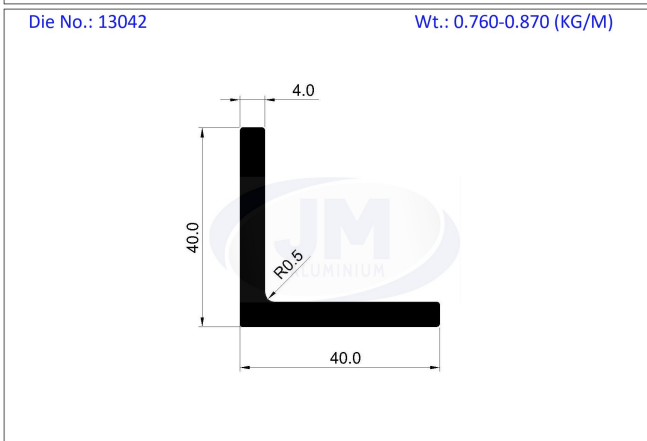
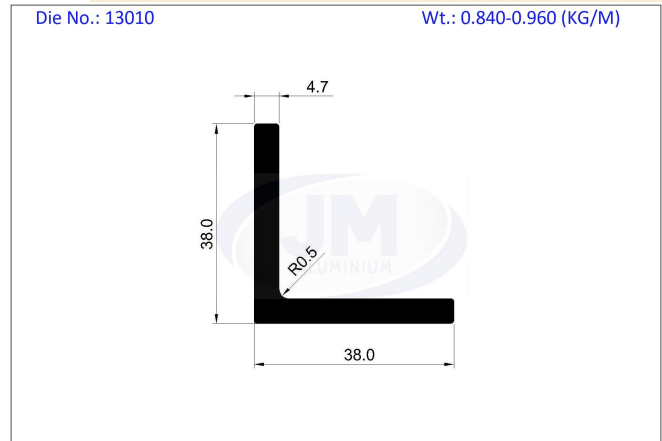
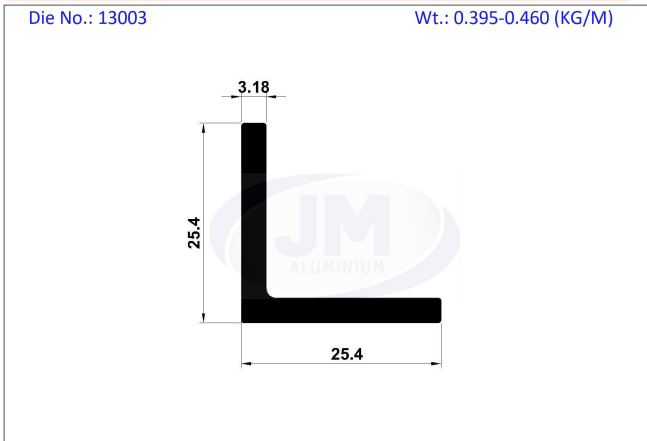

GEOMETRICAL SHAPES

L- Angle

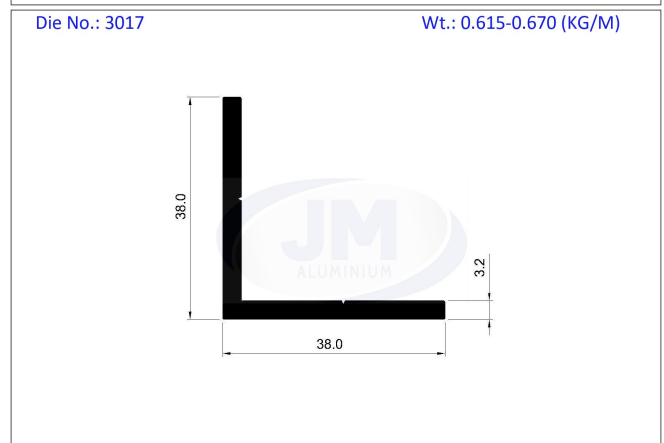
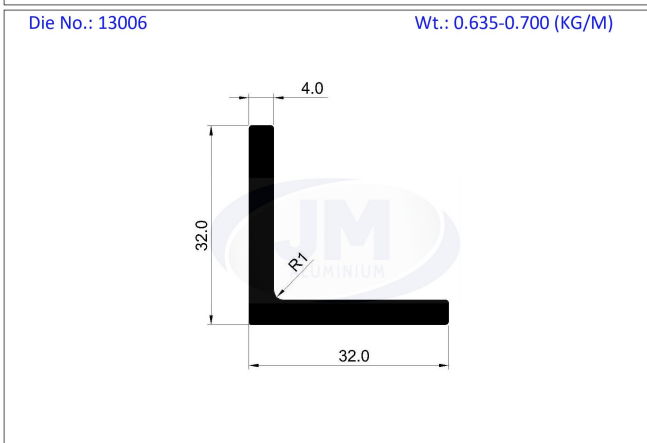
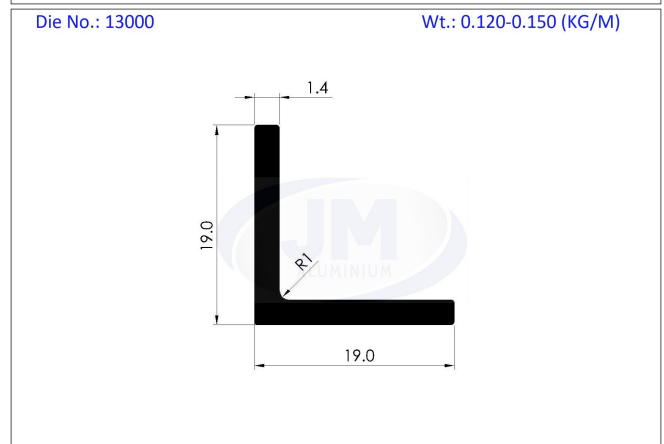
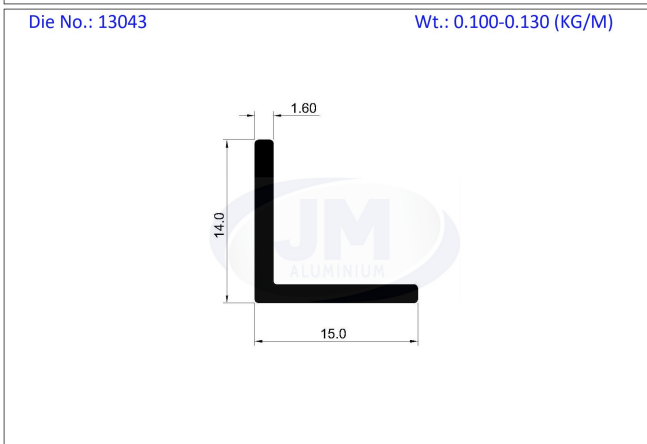
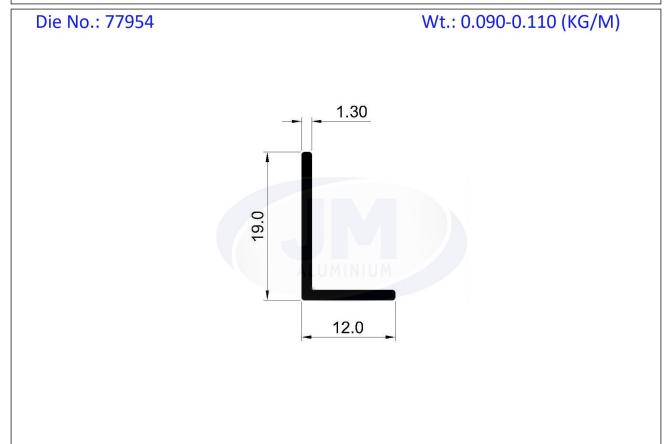
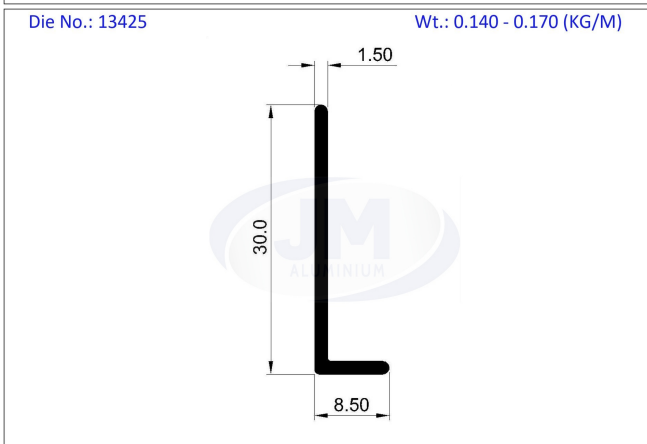
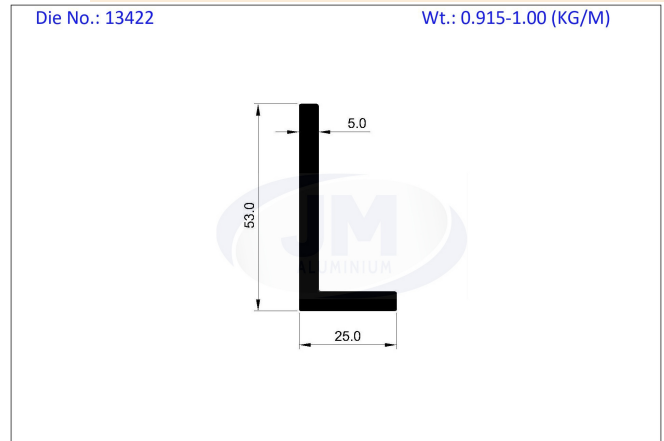
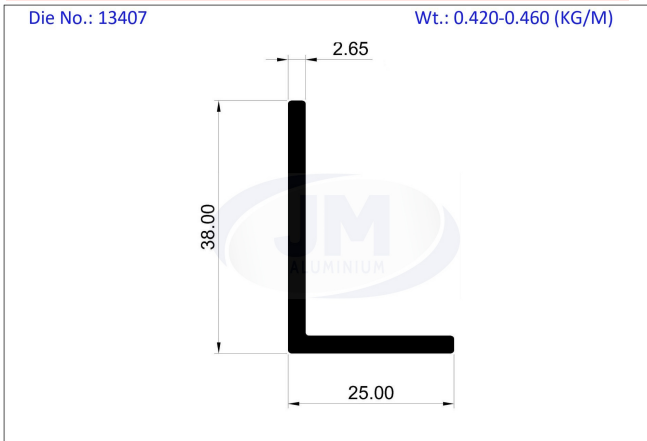

GEOMETRICAL SHAPES

L- Angle

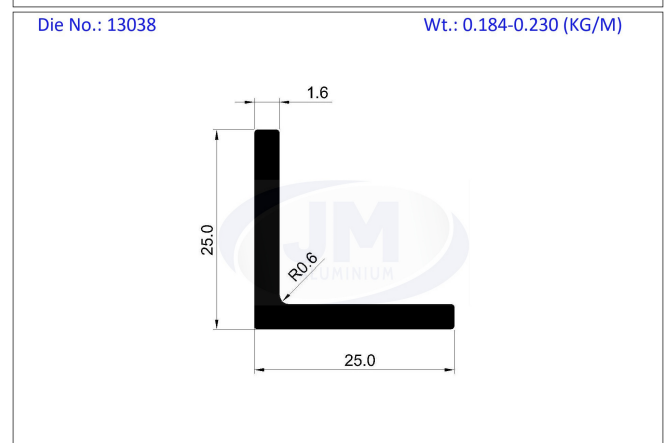
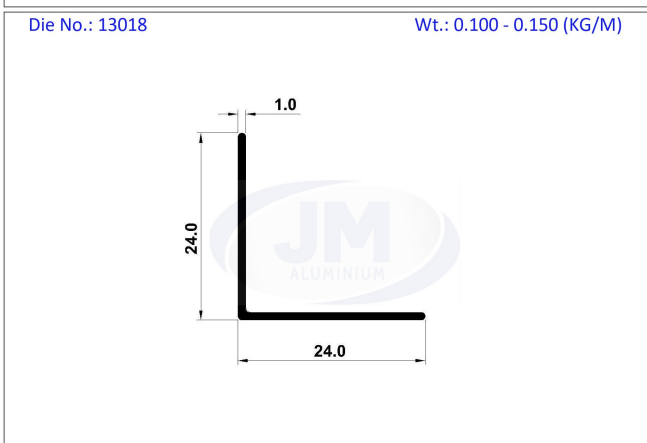
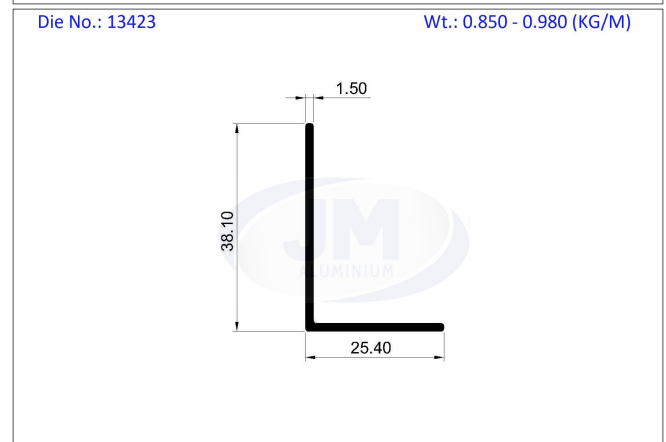
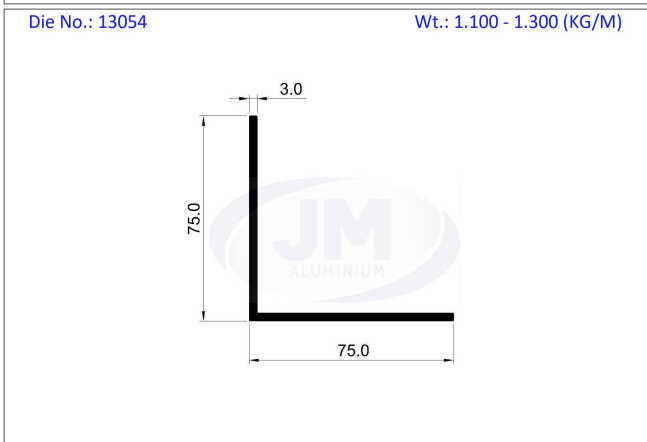
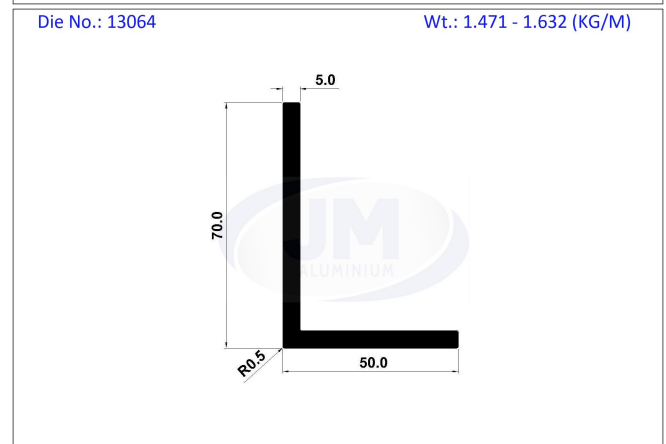
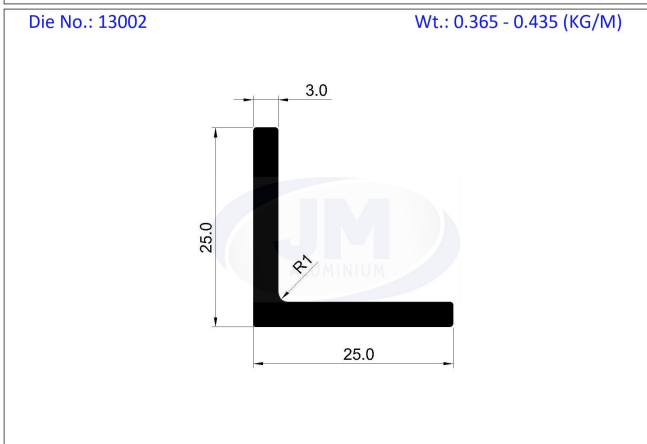
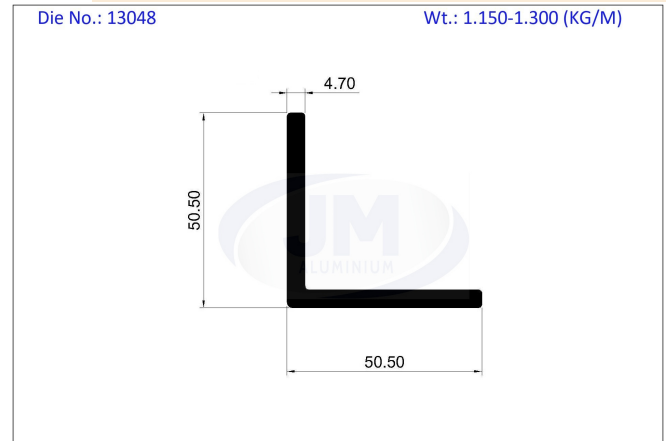
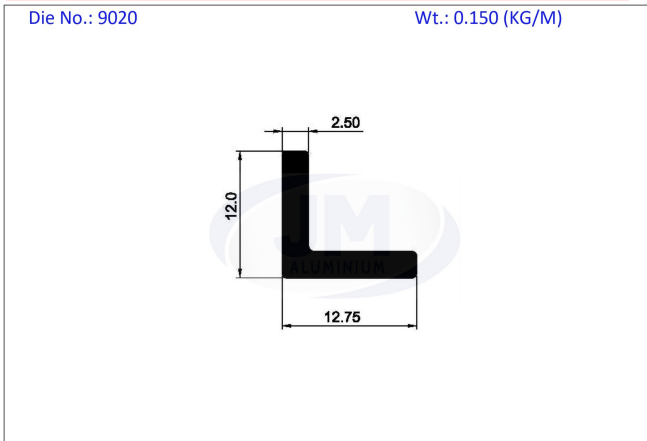

GEOMETRICAL SHAPES

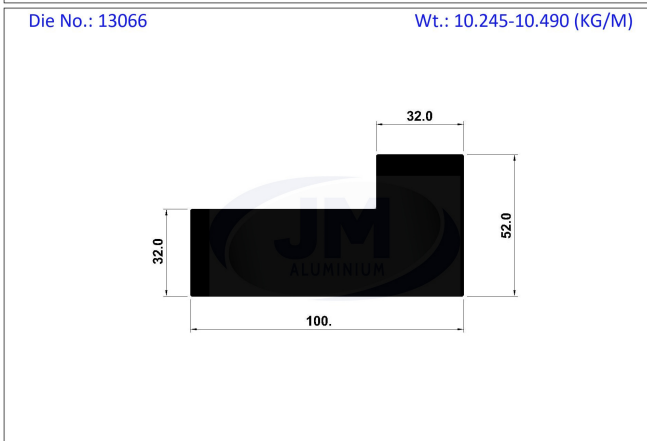
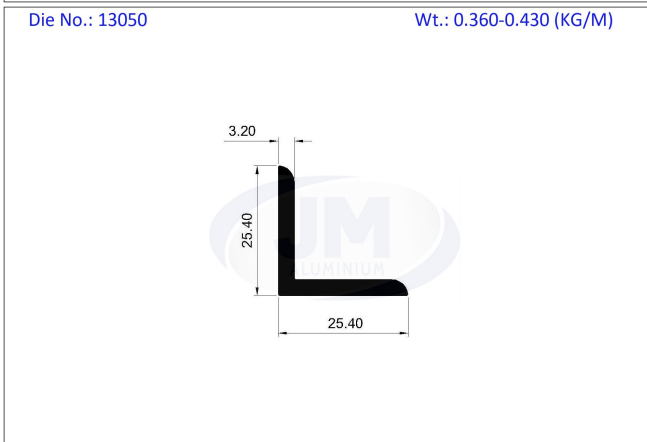
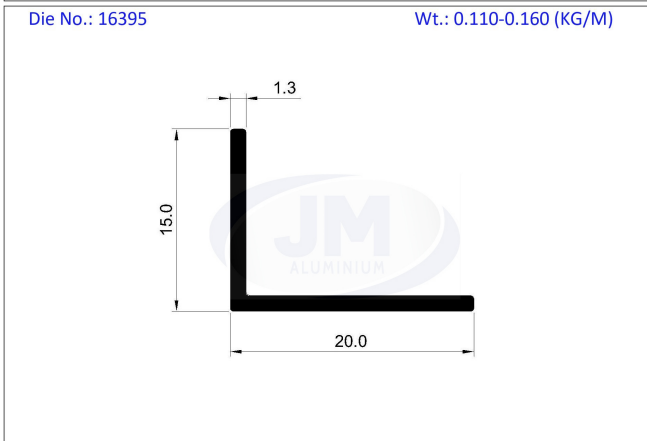
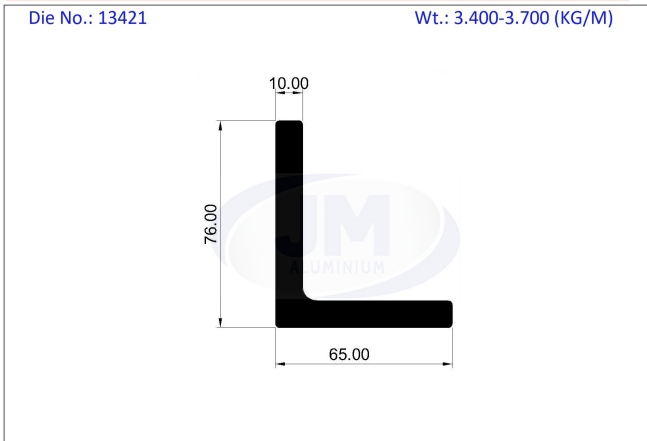

L- Angle

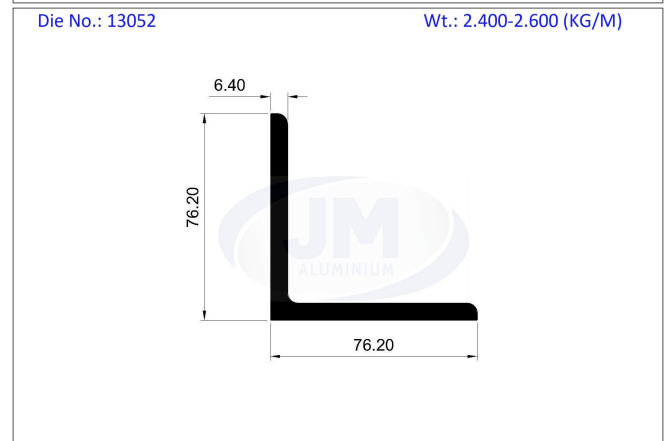
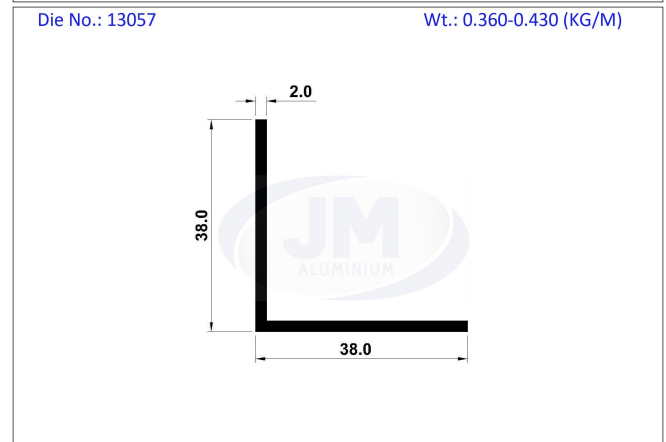
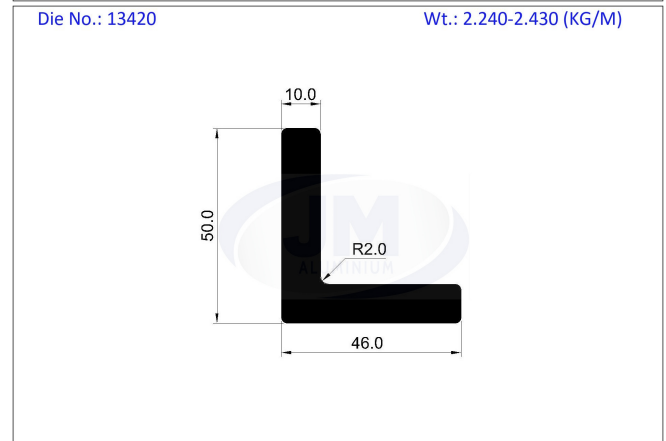
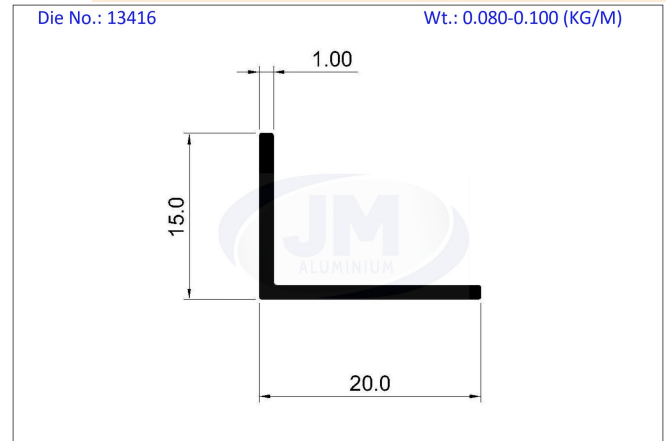

GEOMETRICAL SHAPES

L- Angle

Die No.: 13059

Wt.: 1.130 - 1.270 (KG/M)

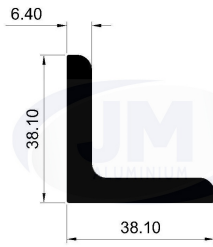

Die No.: 3009

Wt.: 0.180-0.210 (KG/M)

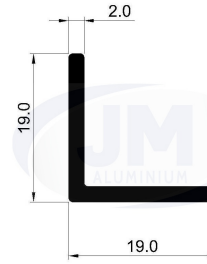

Die No.: 32198

Wt.: 2.426-2.556 (KG/M)

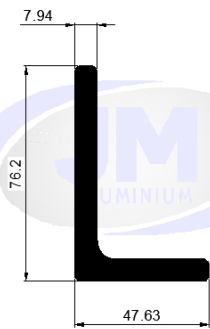

Die No.: 13081

Wt.: 0.173-0.224 (KG/M)

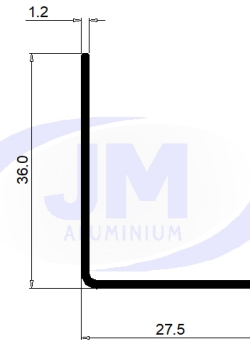

Die No.: 13103

Wt.: 1.089 - 1.291 (KG/M)

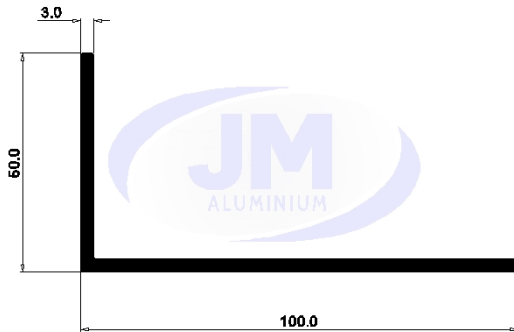

Die No.: 13104

Wt.: 0.828 - 0.920 (KG/M)

