

**GEOMETRICAL SHAPES**

**Flat Bar**

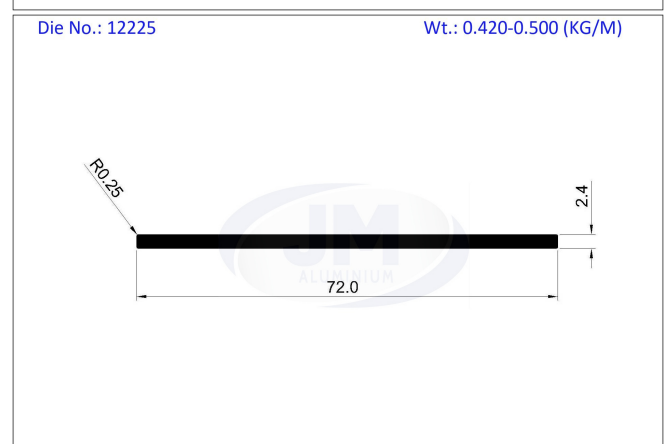
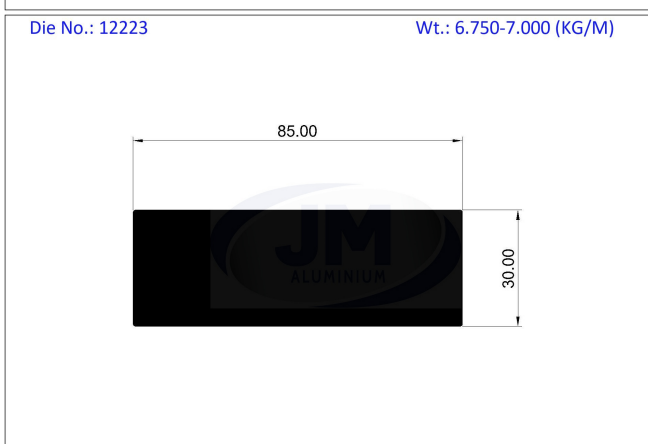
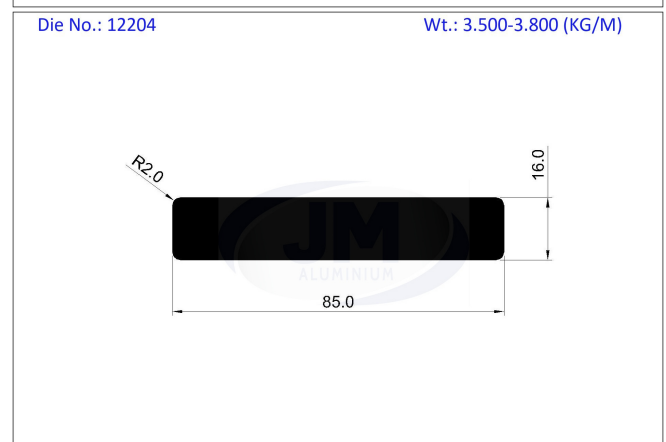
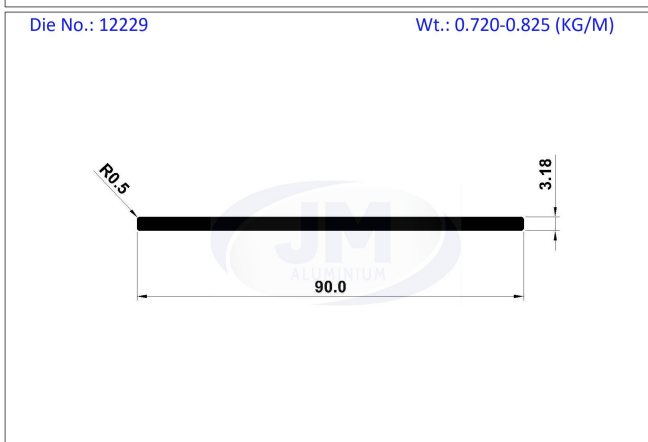
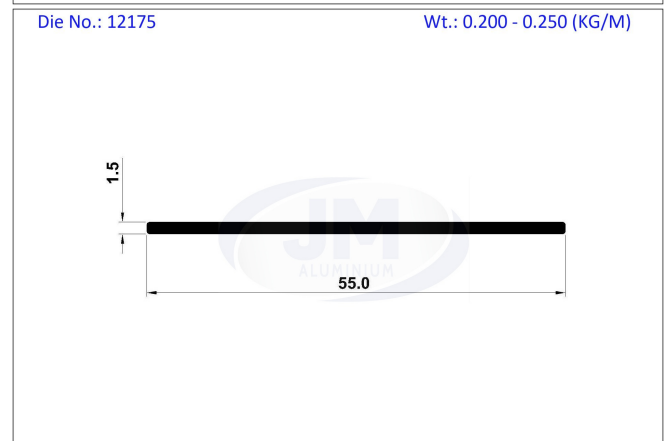
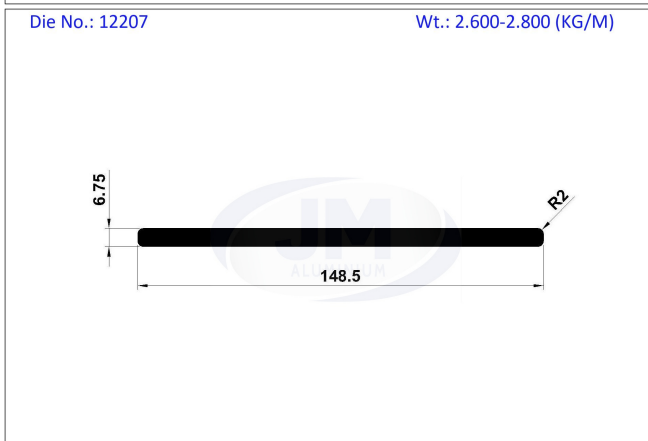
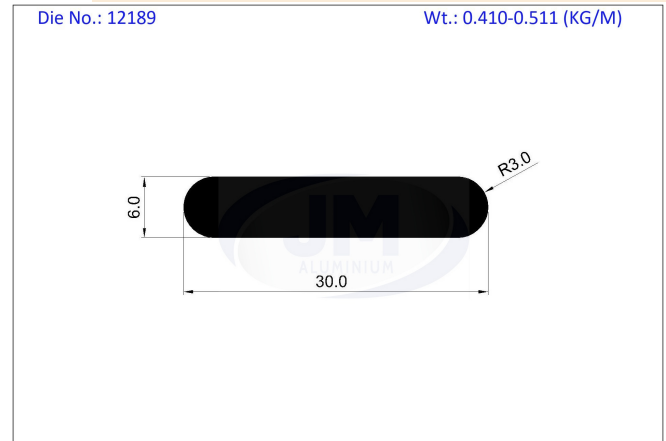
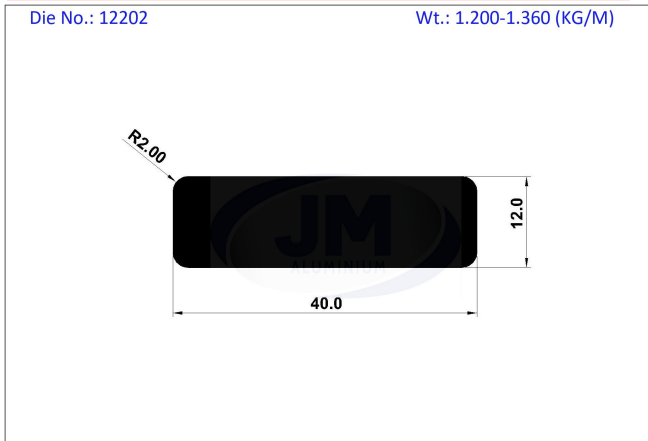

**GEOMETRICAL SHAPES**

**Flat Bar**

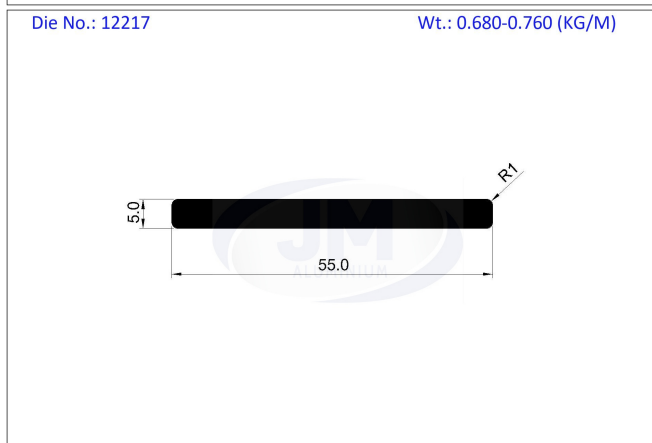
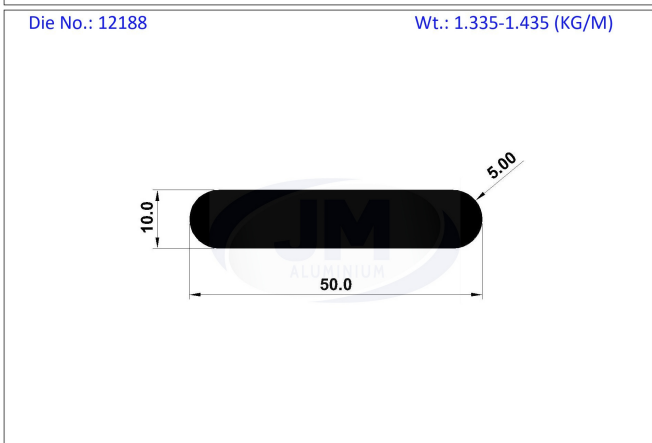
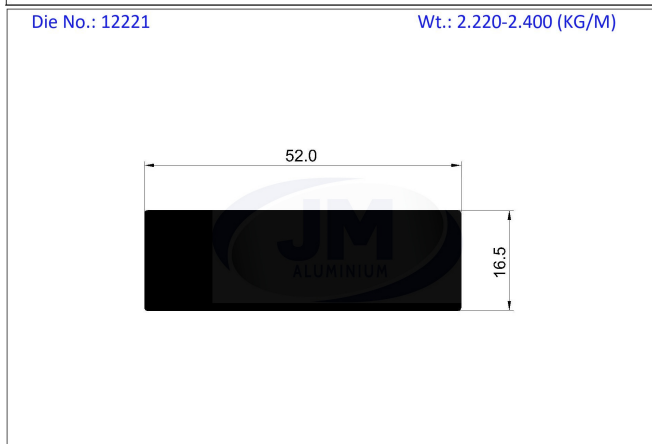
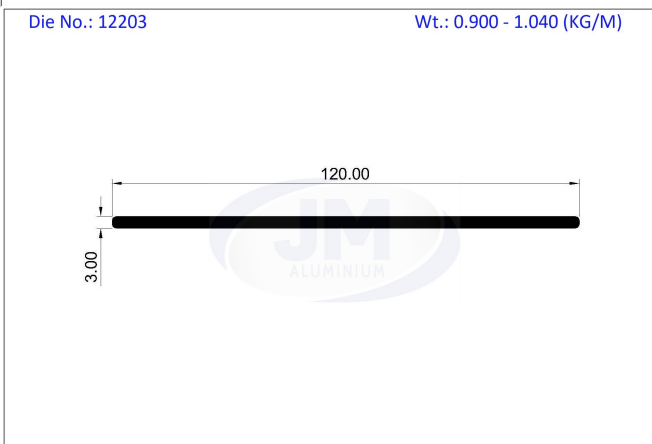
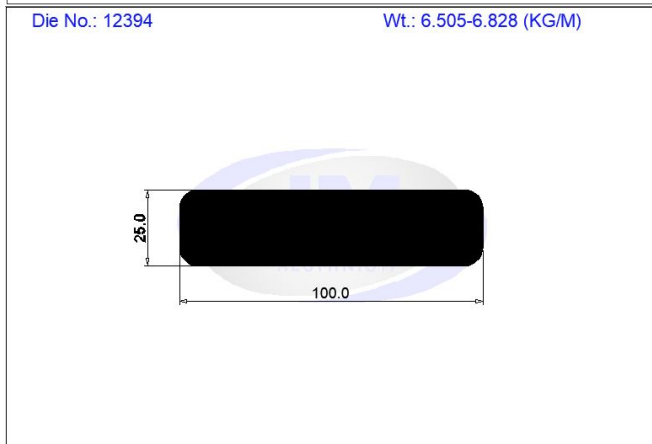
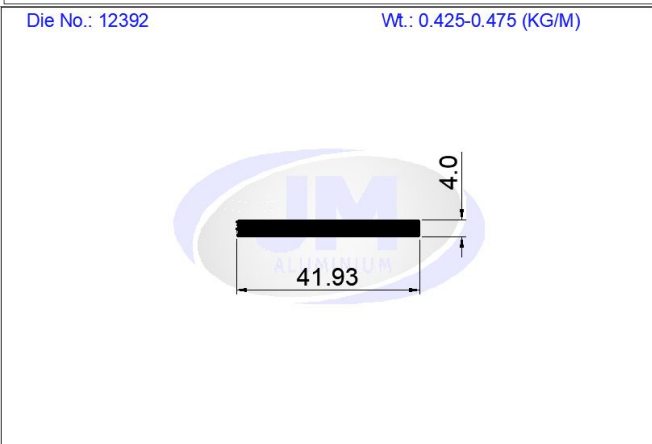
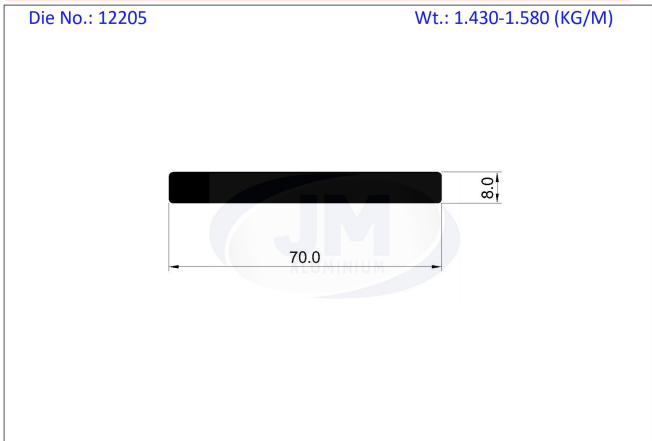

**GEOMETRICAL SHAPES**

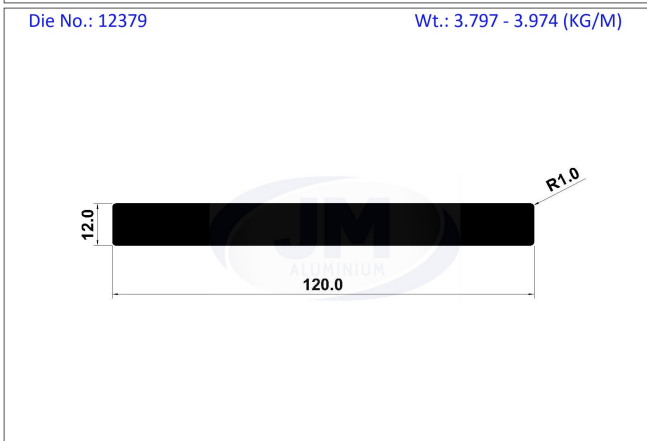
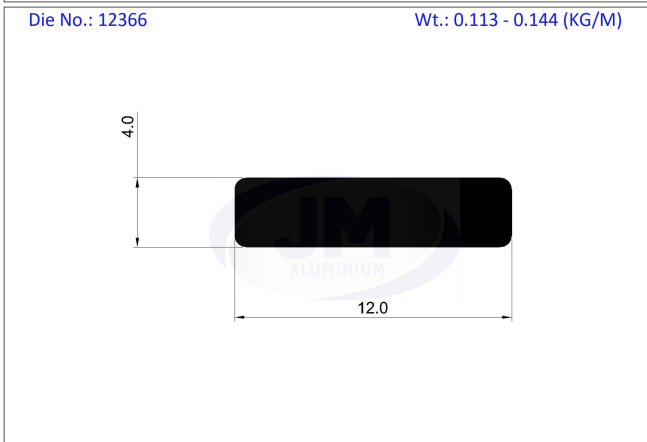
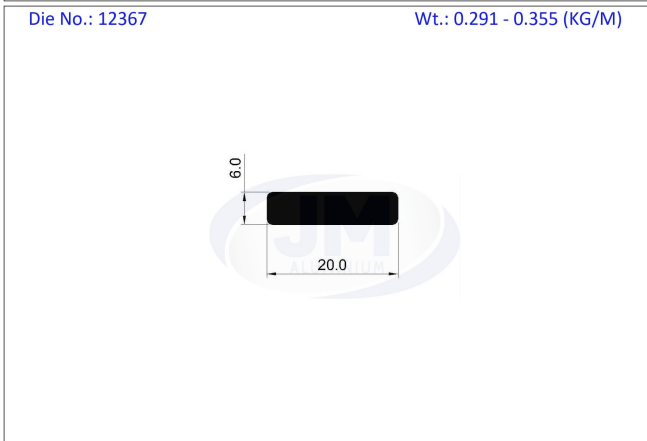
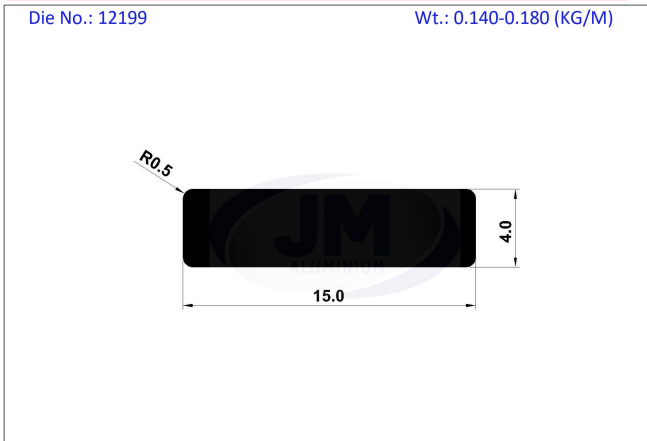

**Flat Bar**

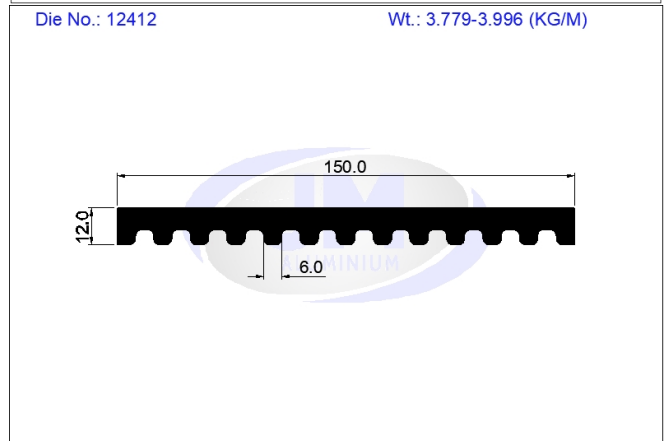
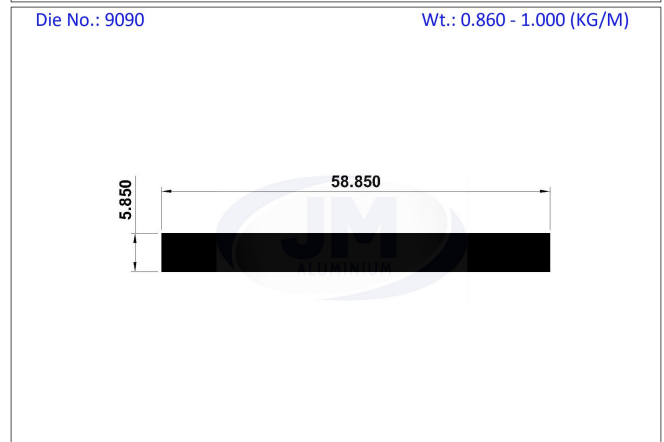
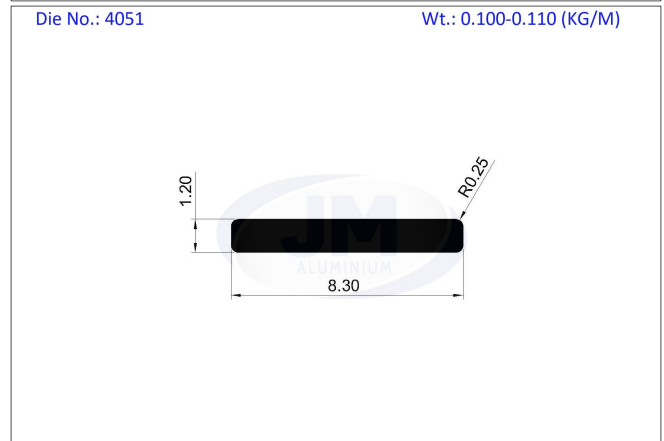
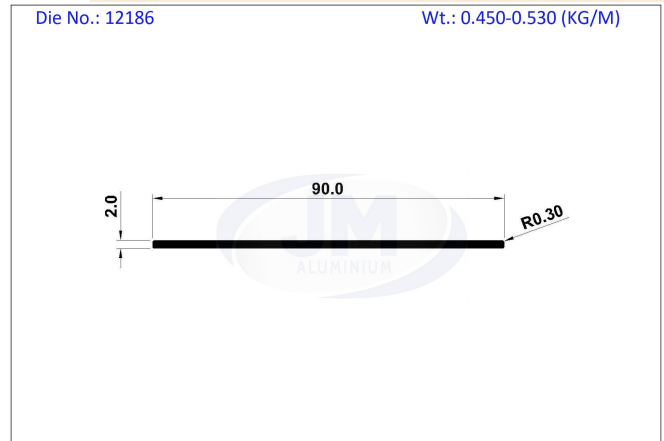

**GEOMETRICAL SHAPES**

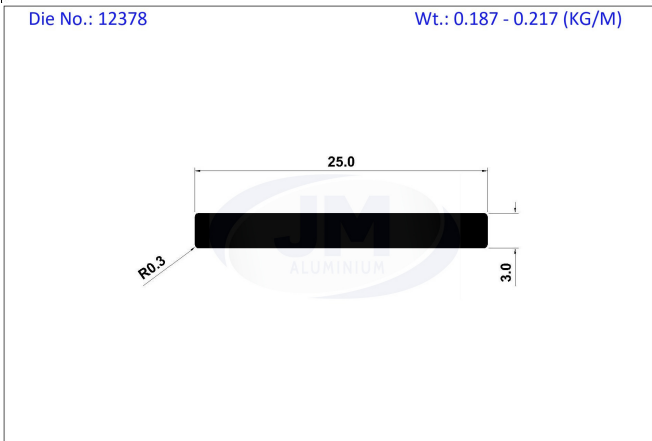
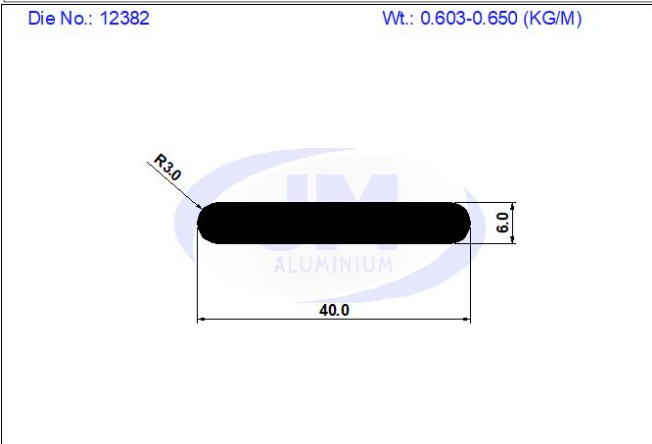
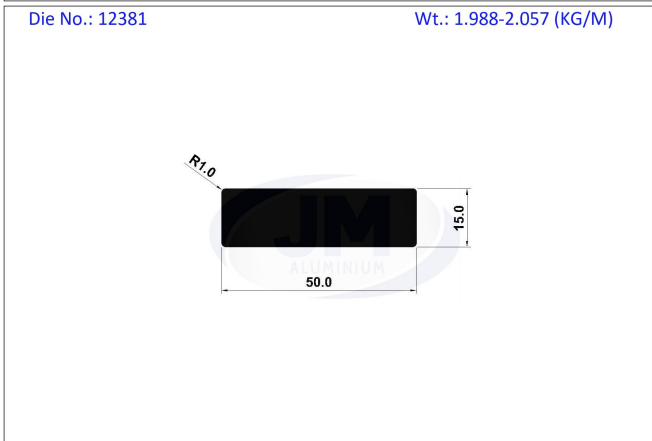
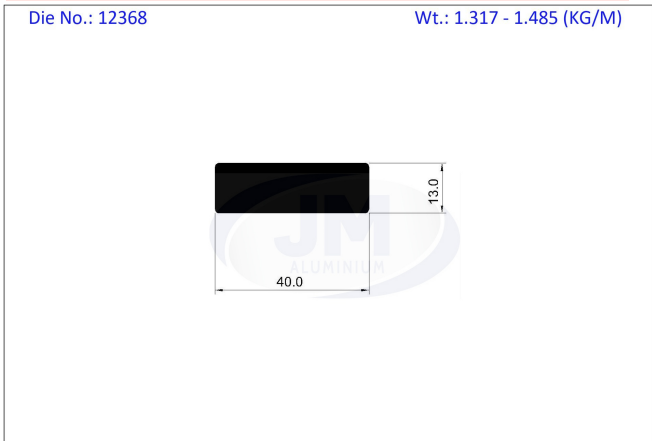

**Flat Bar**

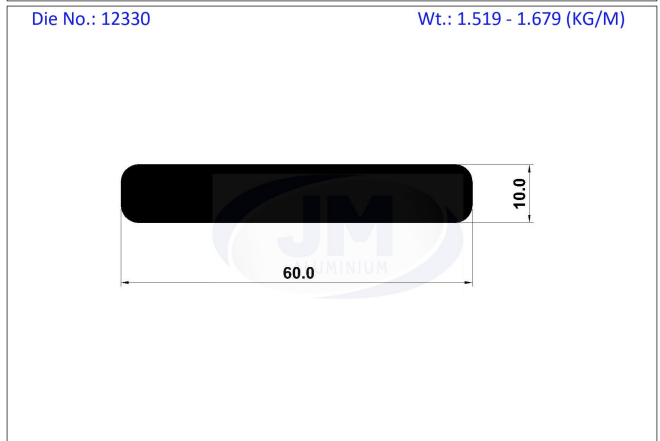
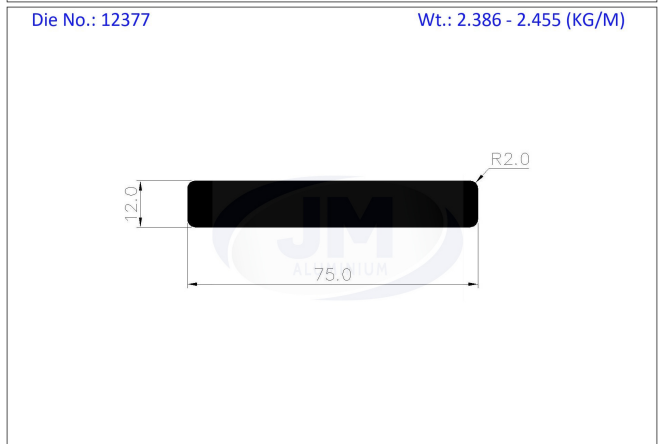
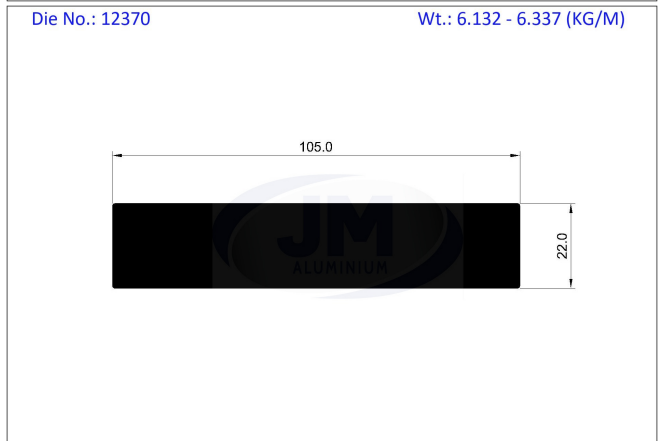
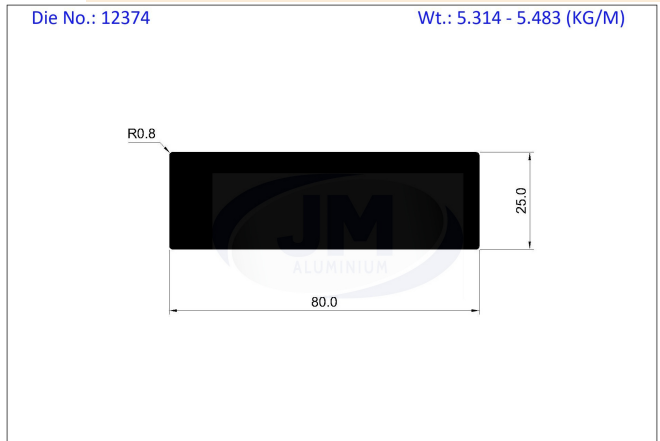



**GEOMETRICAL SHAPES**

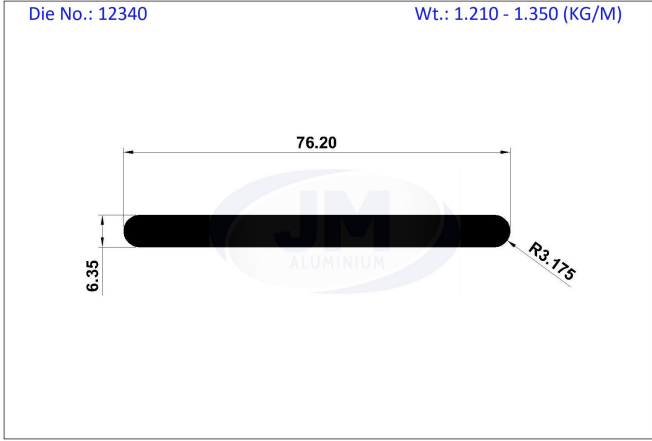
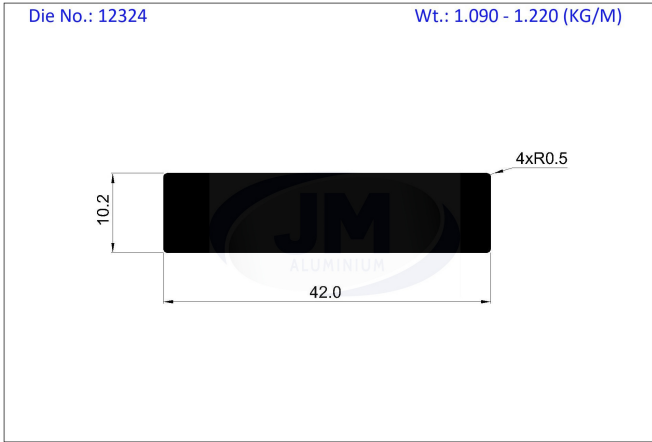
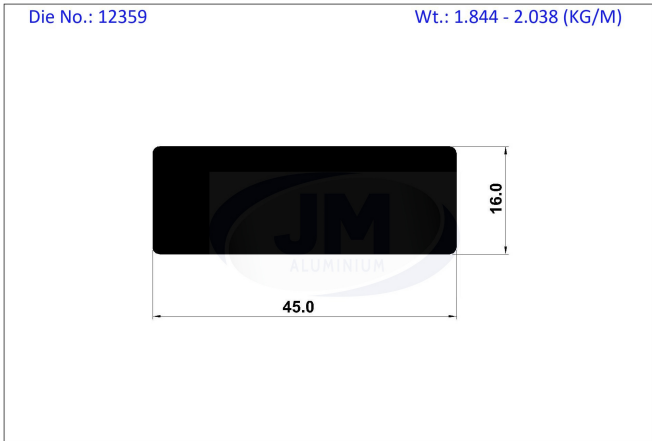
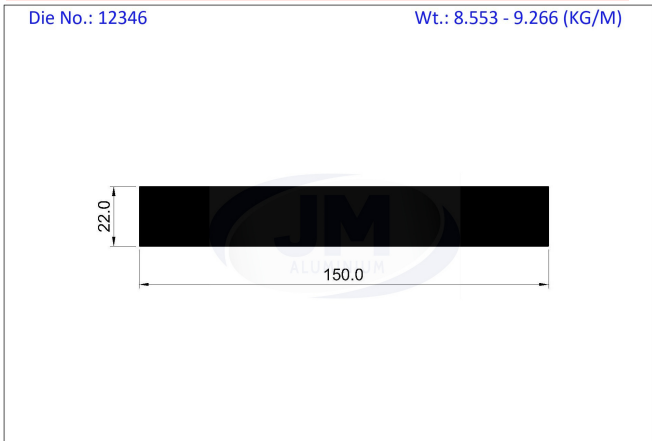

**Flat Bar**

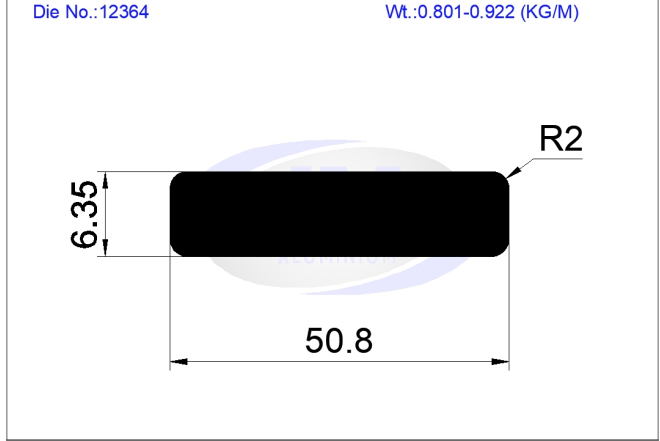
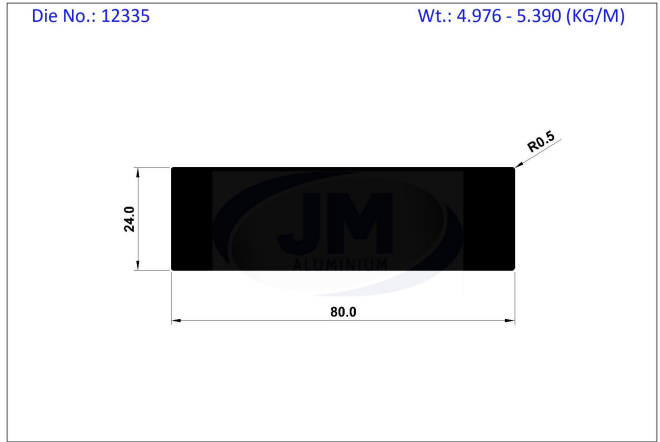
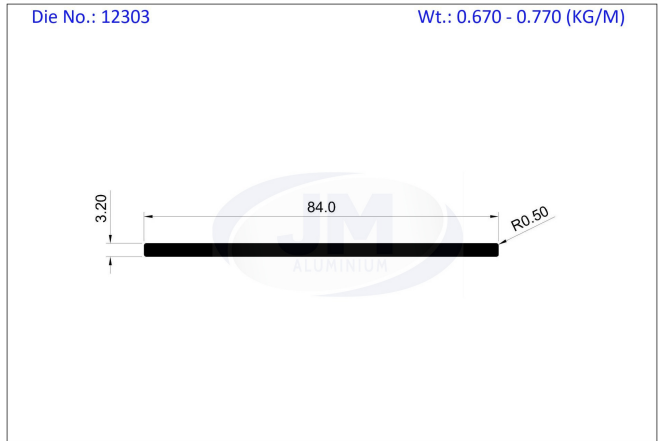
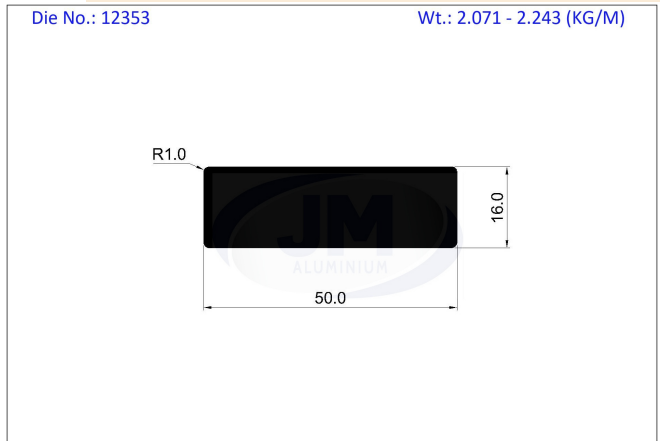

**GEOMETRICAL SHAPES**

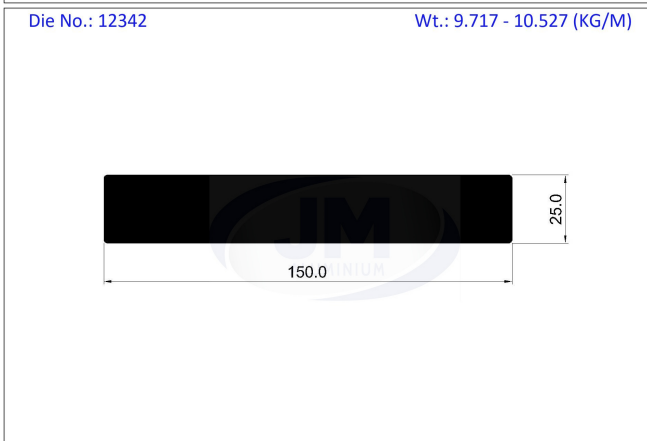
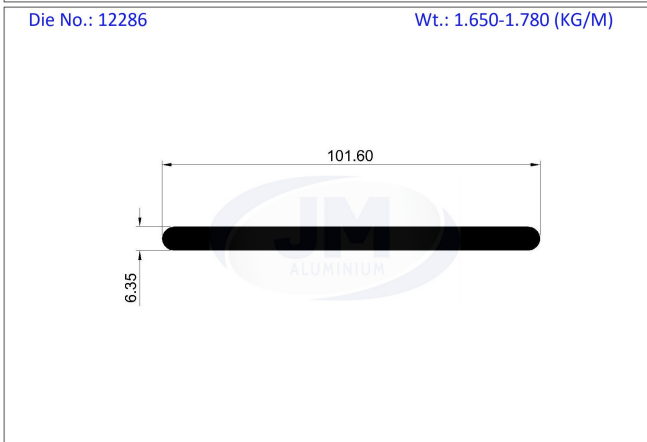
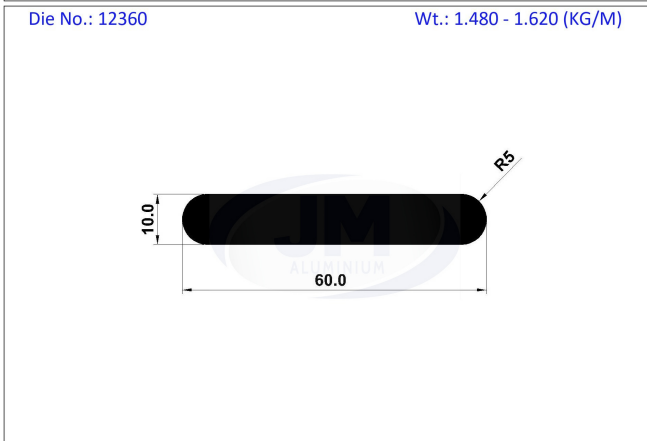
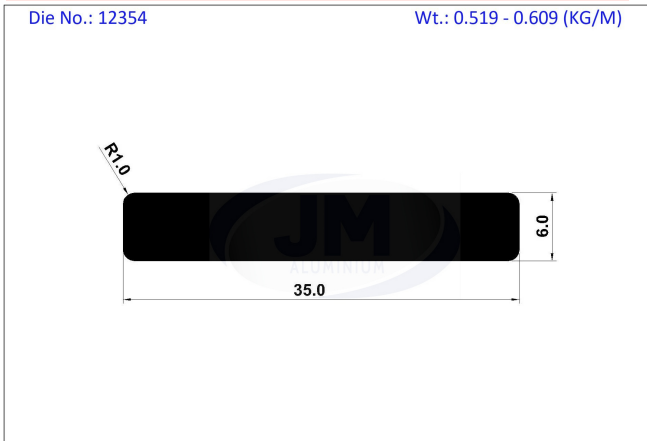

**Flat Bar**

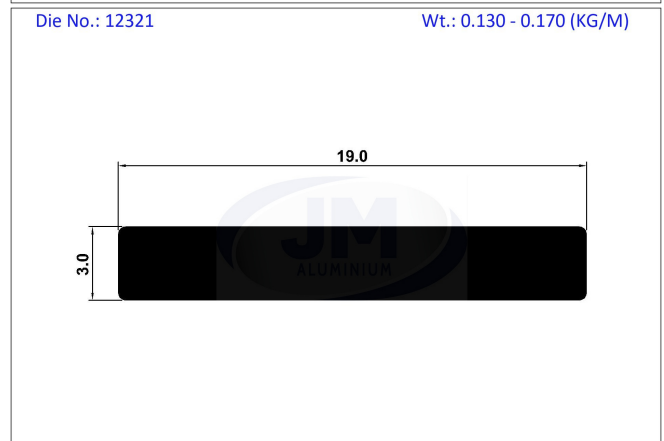
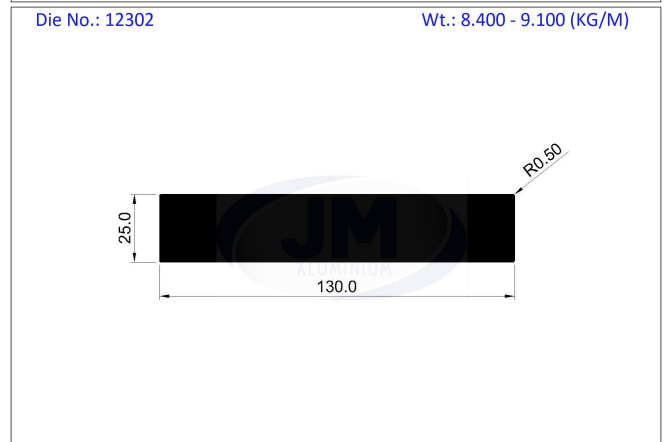
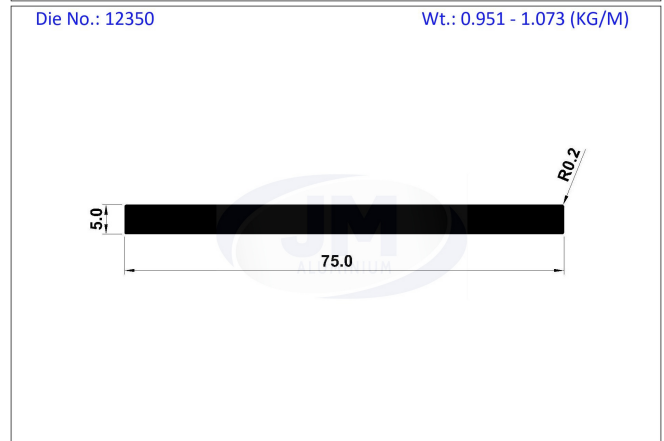
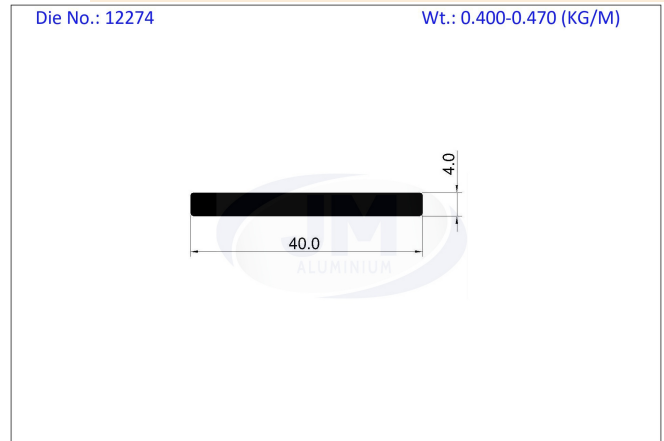

**GEOMETRICAL SHAPES**

**Flat Bar**

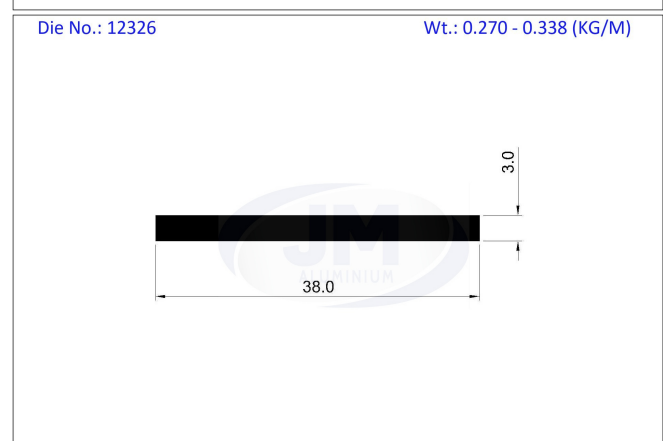
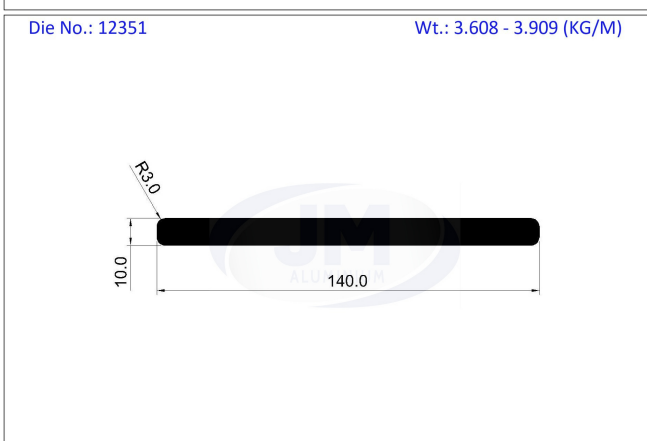
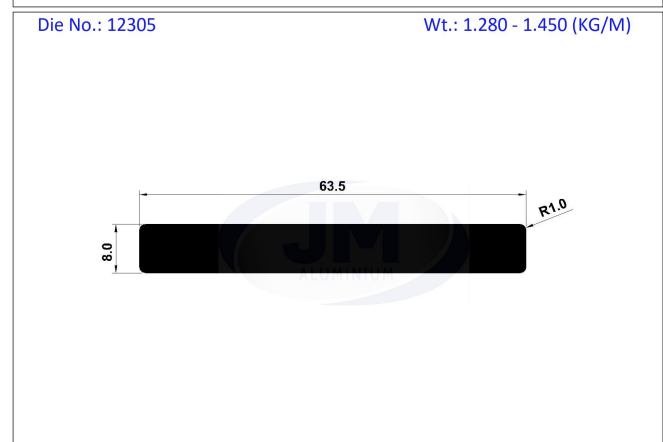
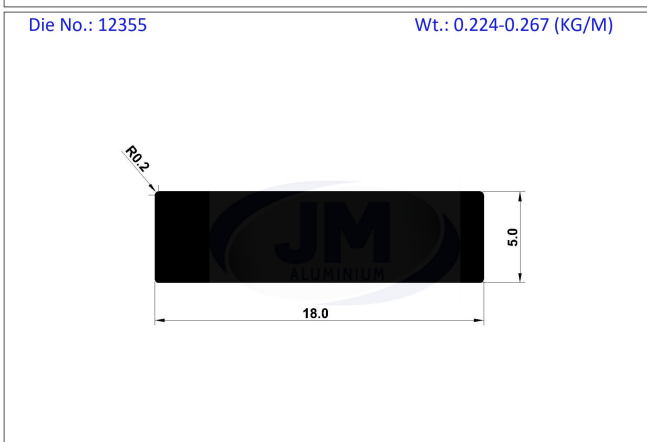
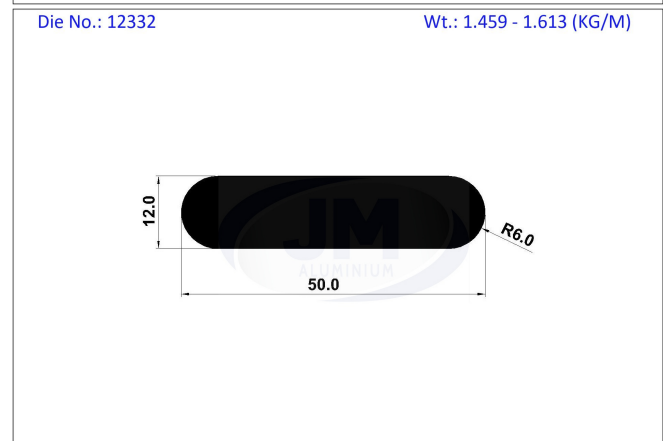
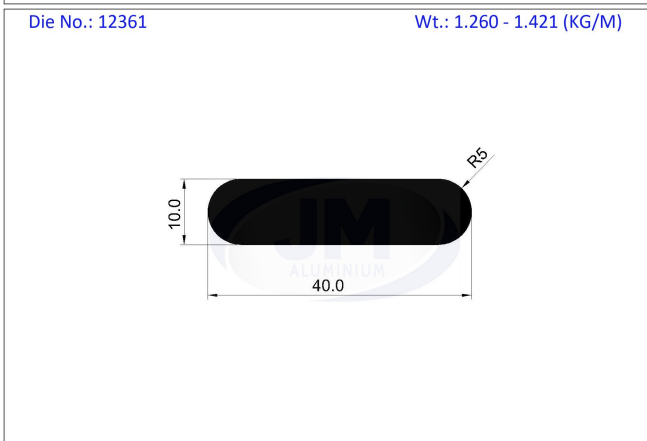
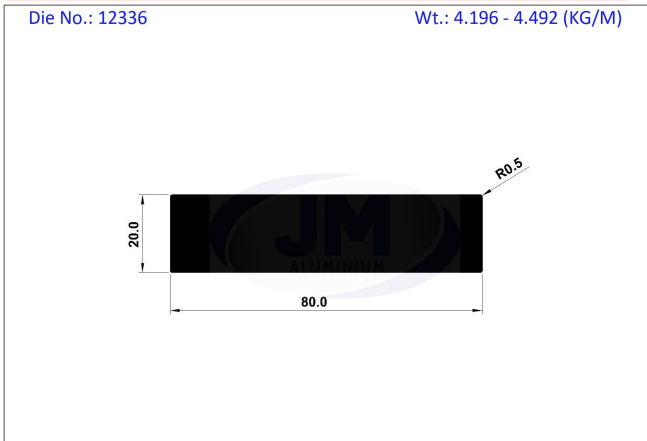

**GEOMETRICAL SHAPES**

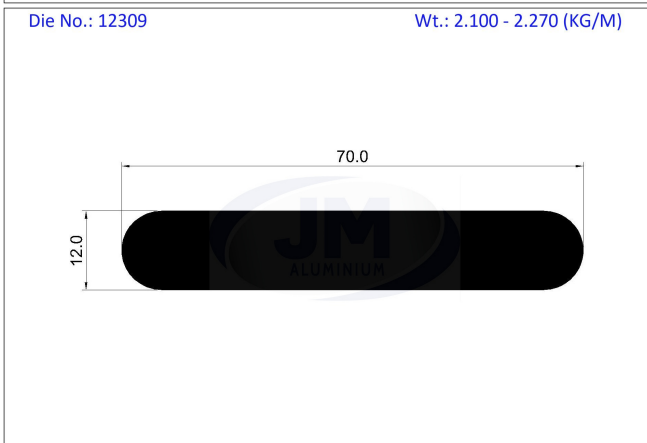
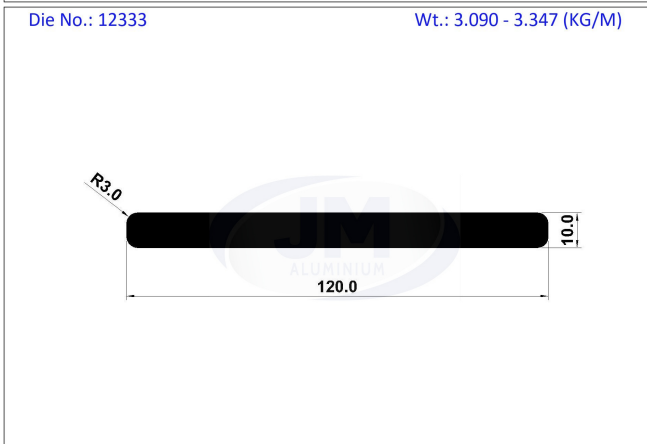
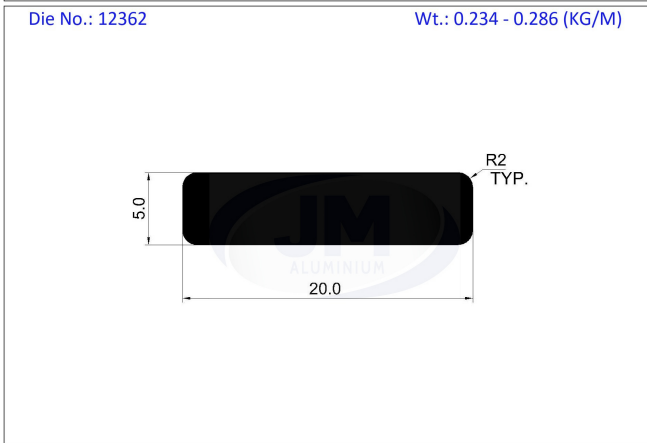
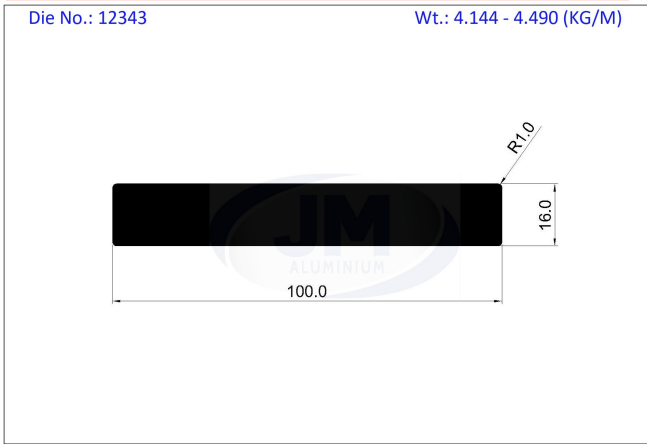

**Flat Bar**

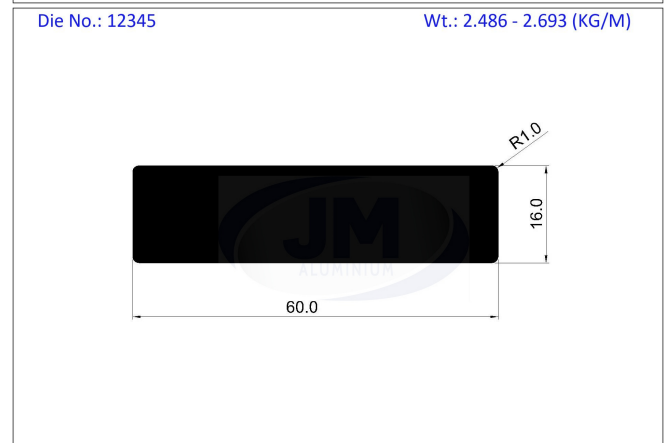
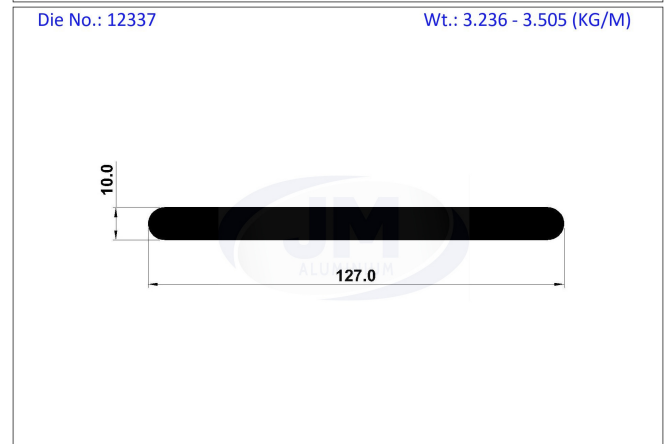
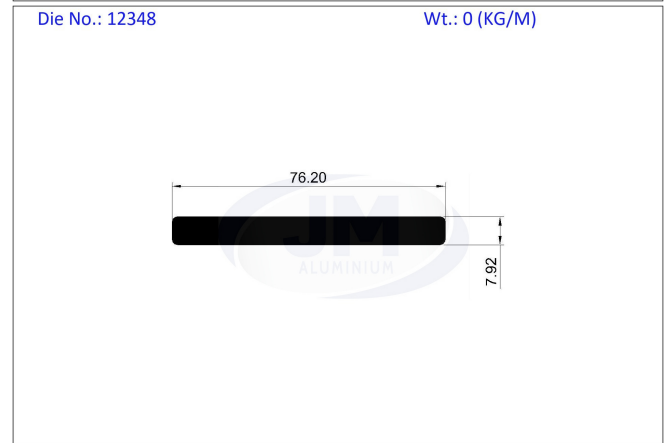
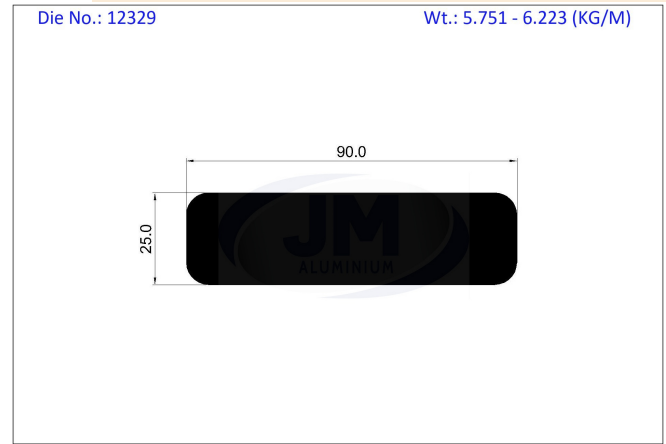

**GEOMETRICAL SHAPES**

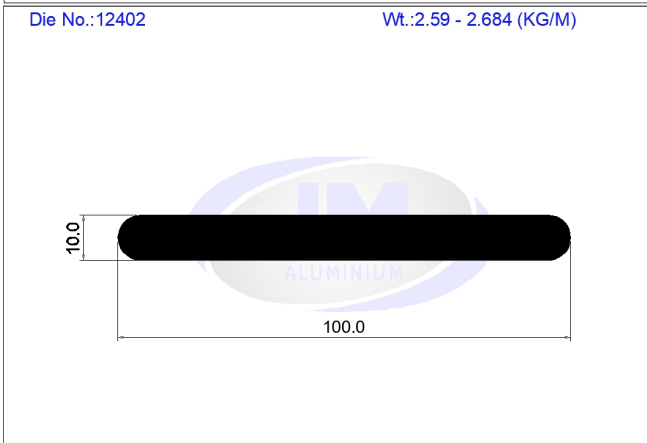
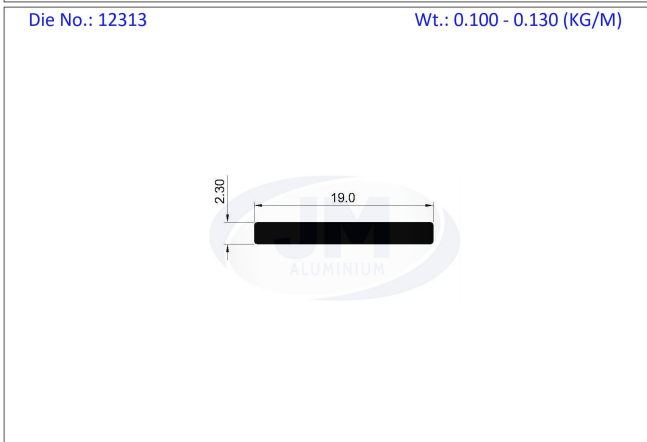
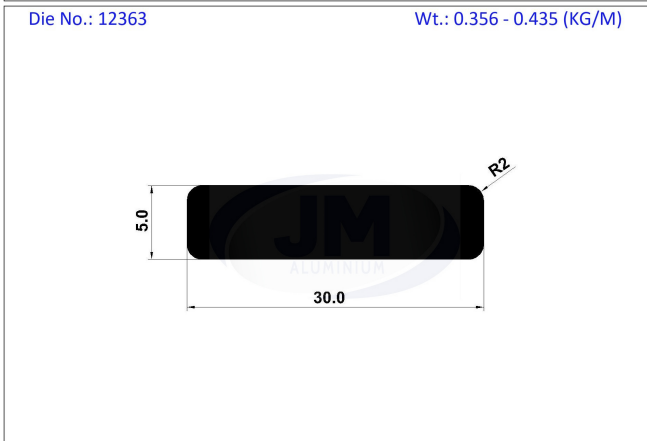
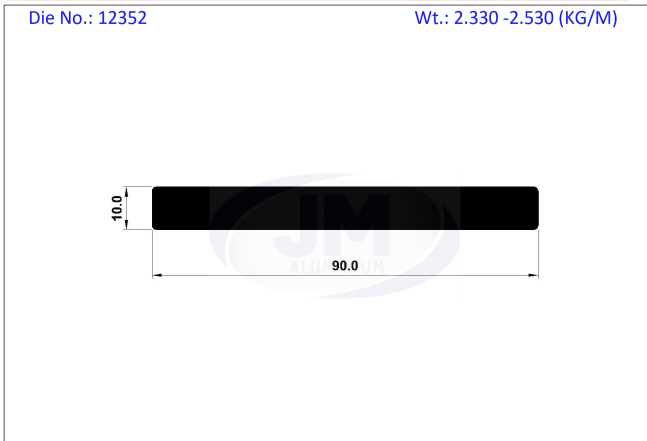

**Flat Bar**

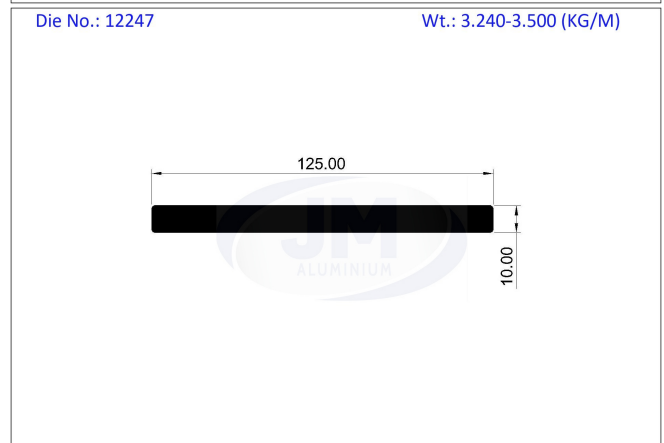
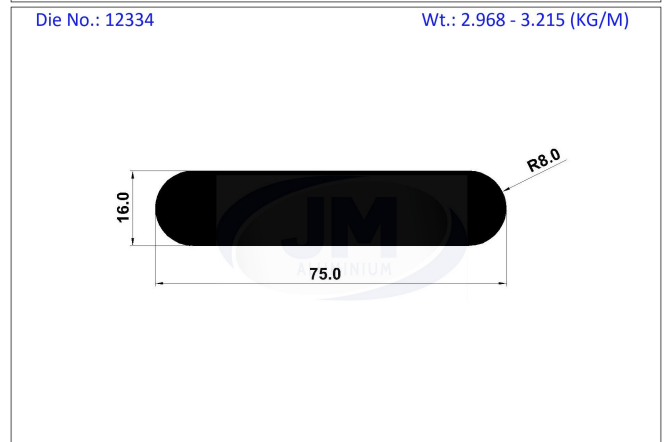
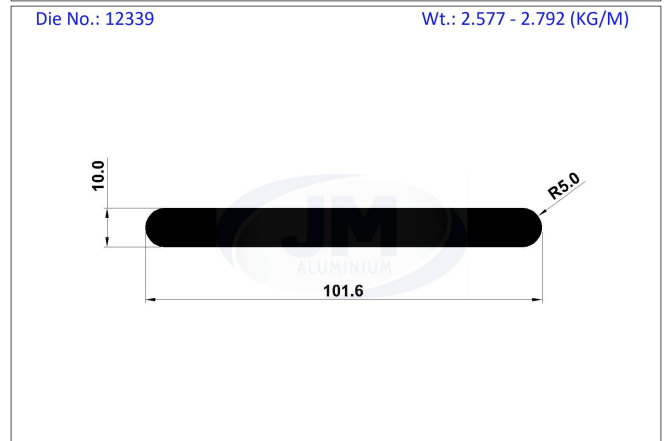
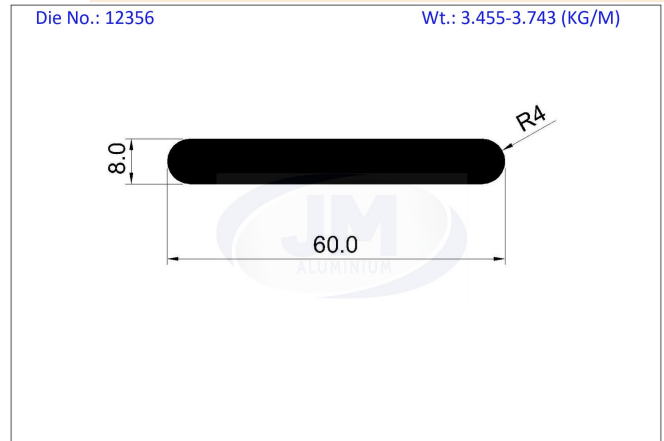

**GEOMETRICAL SHAPES**

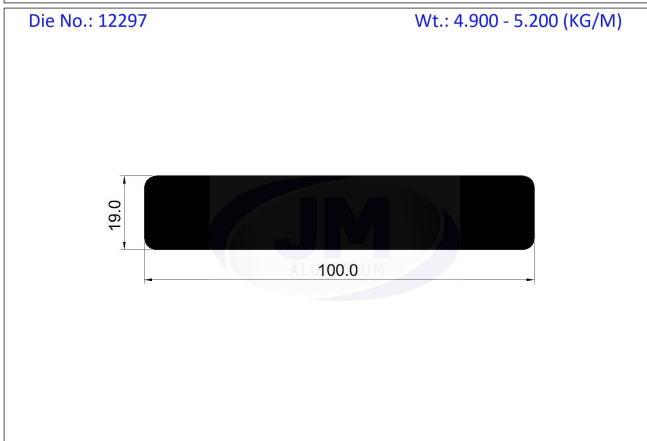
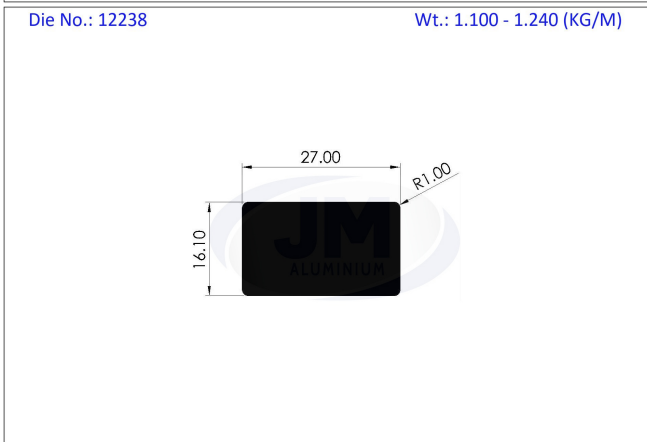
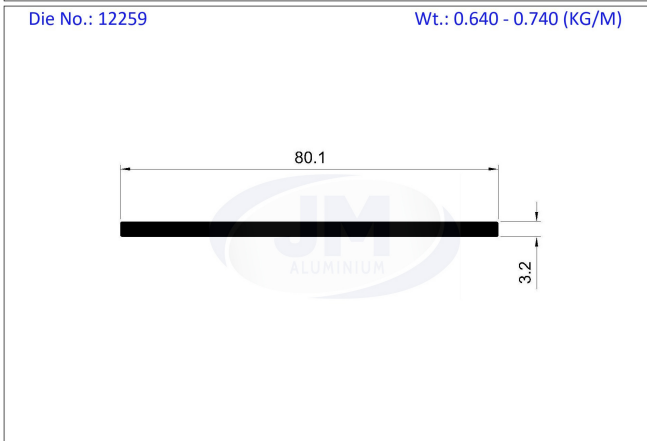
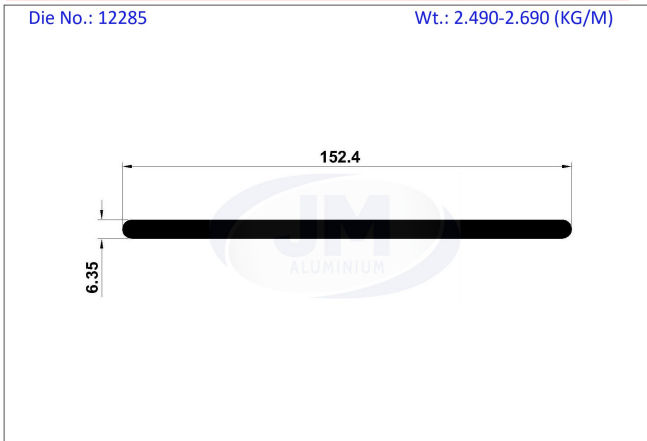

**Flat Bar**

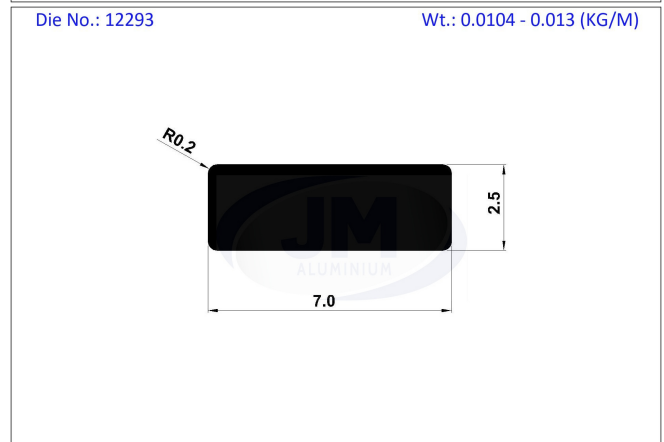
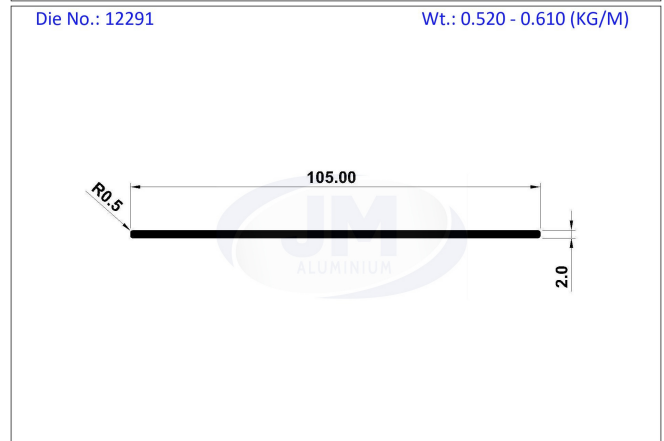
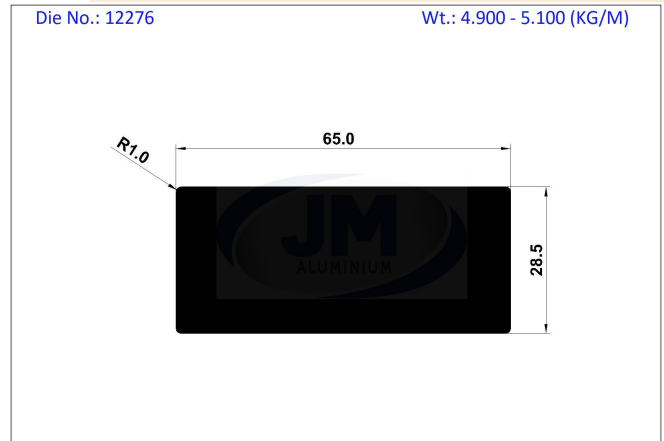

**GEOMETRICAL SHAPES**

**Flat Bar**

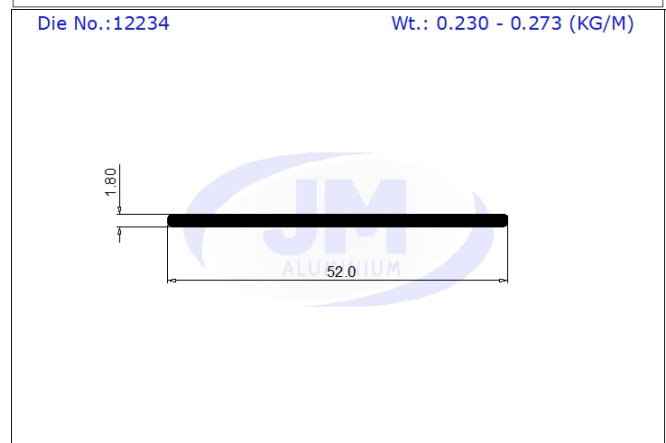
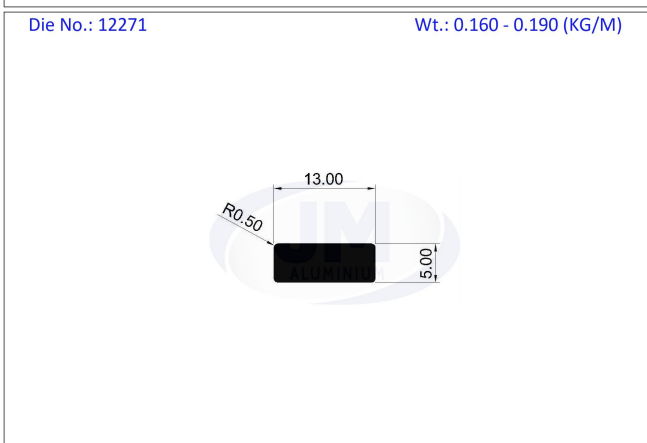
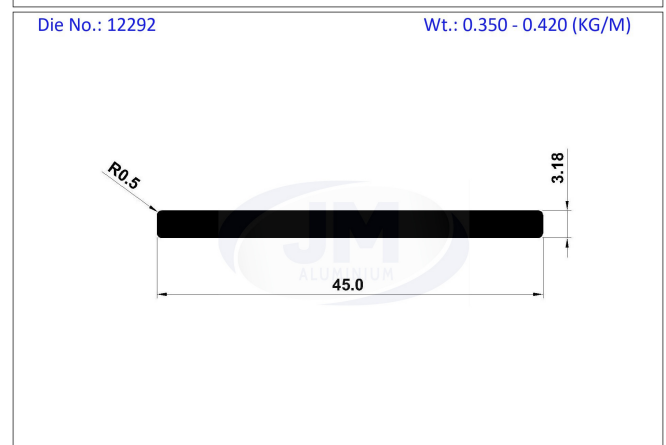
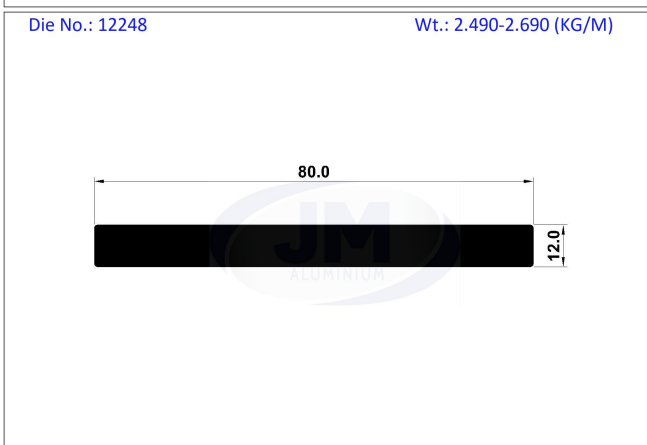
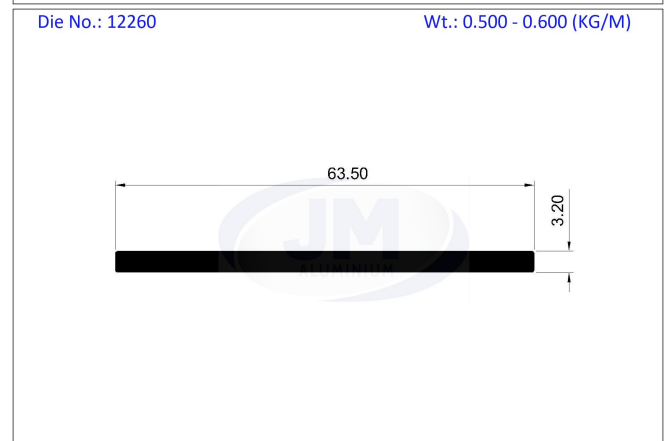
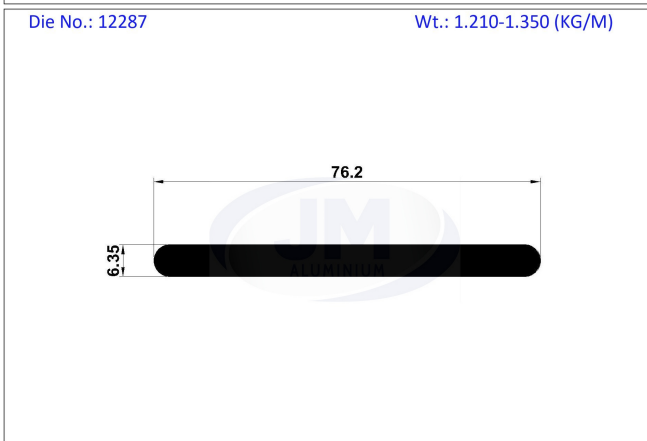
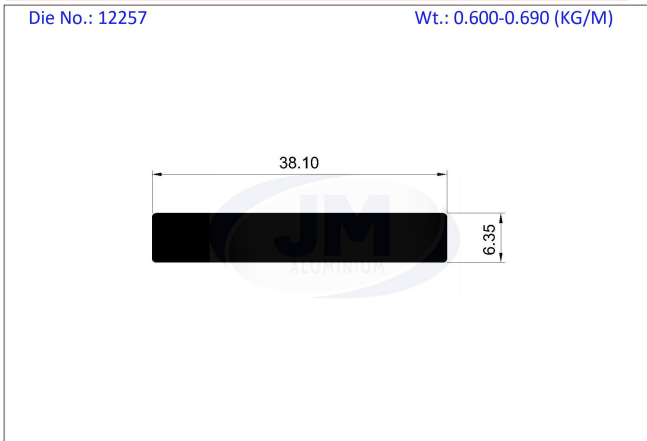

**GEOMETRICAL SHAPES**

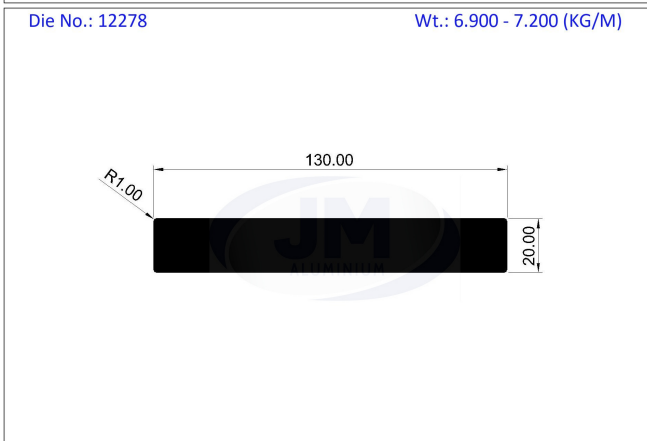
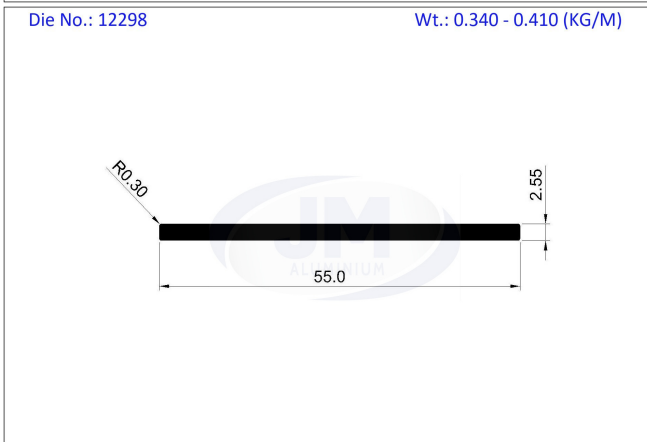
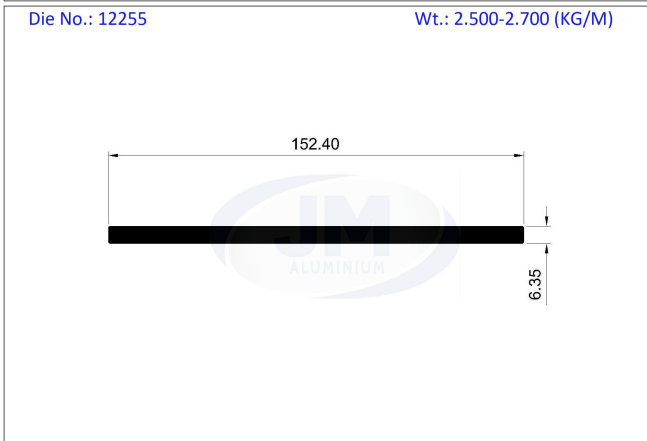
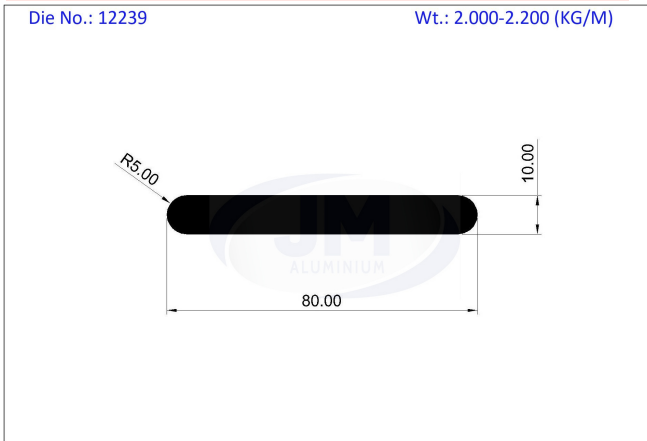

**Flat Bar**

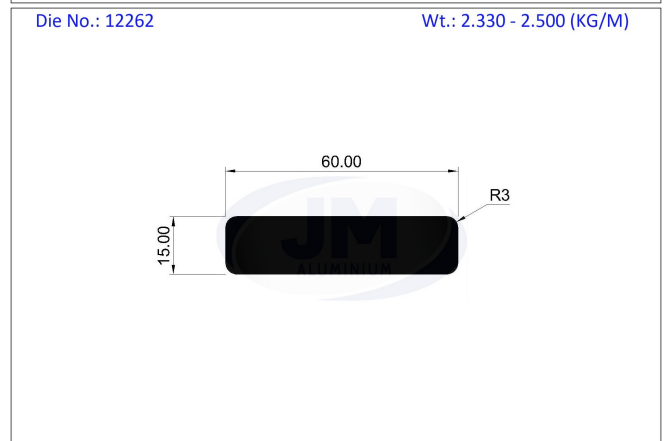
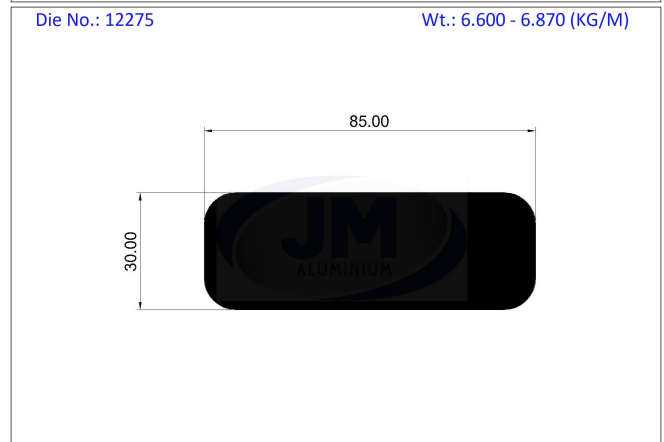
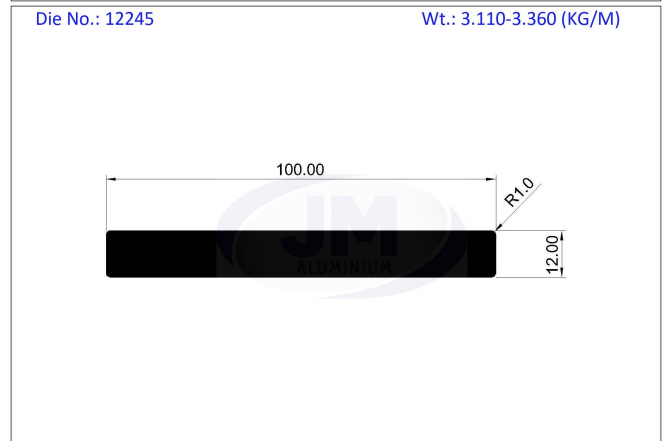
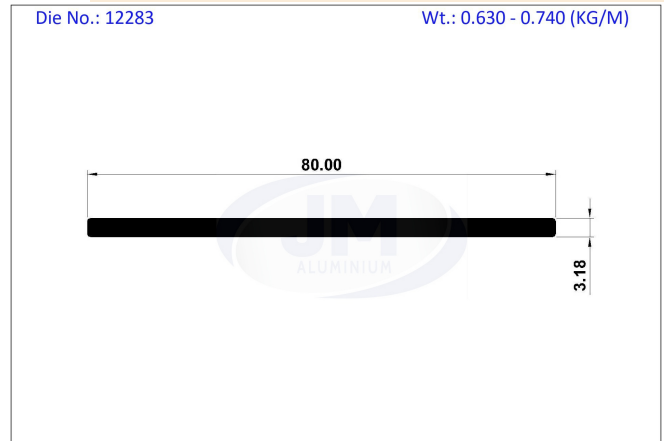



**GEOMETRICAL SHAPES**

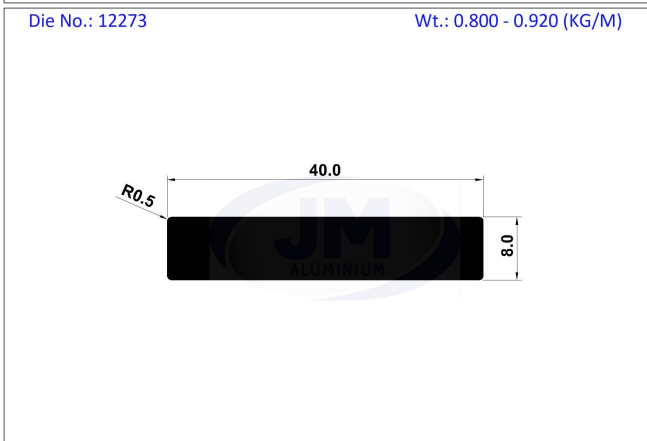
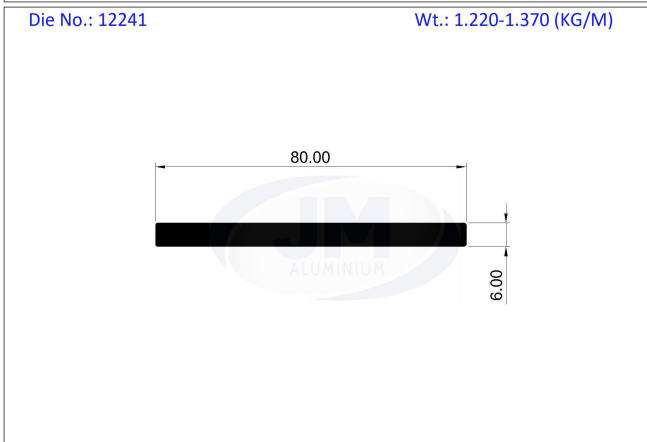
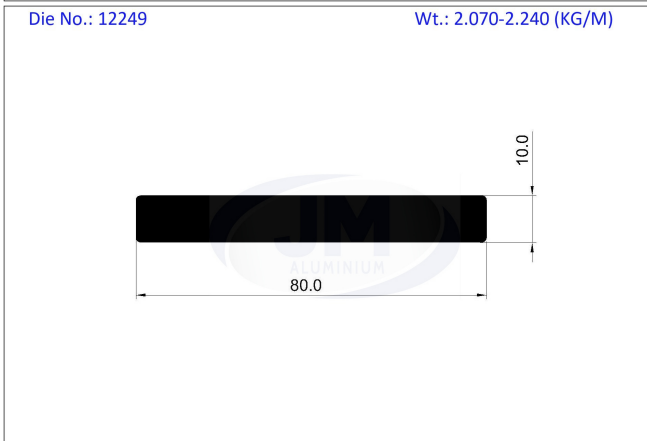
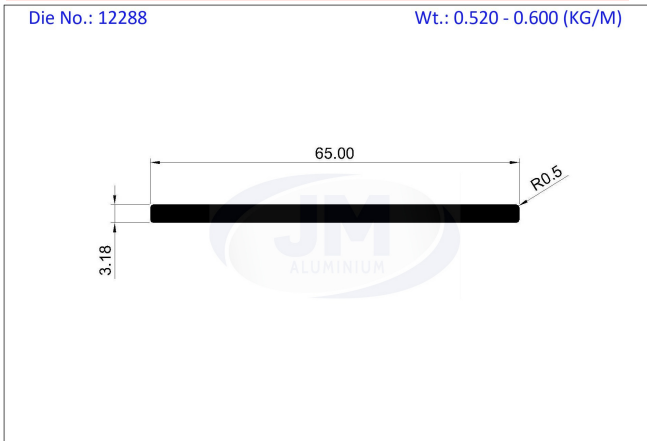

**Flat Bar**

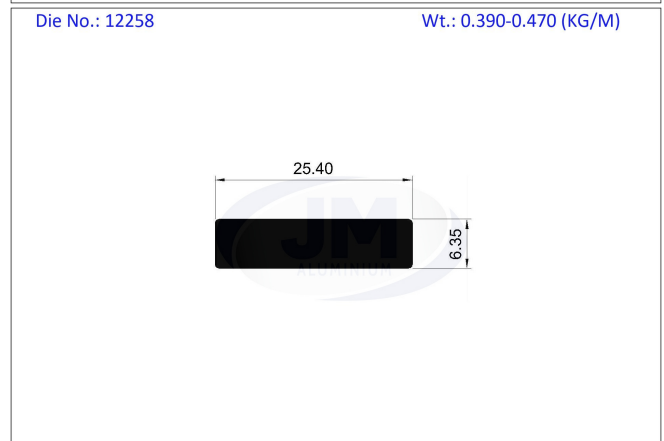
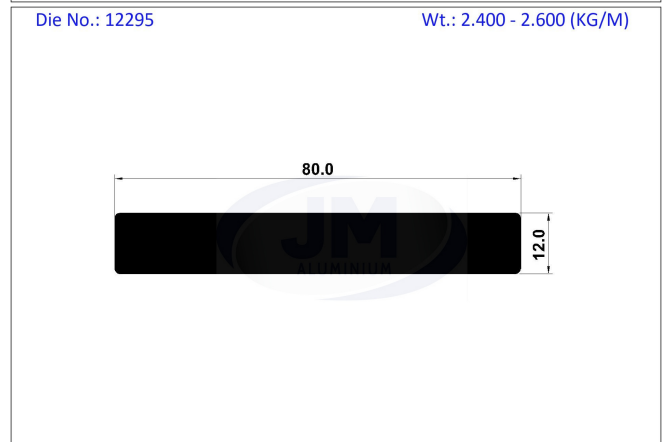
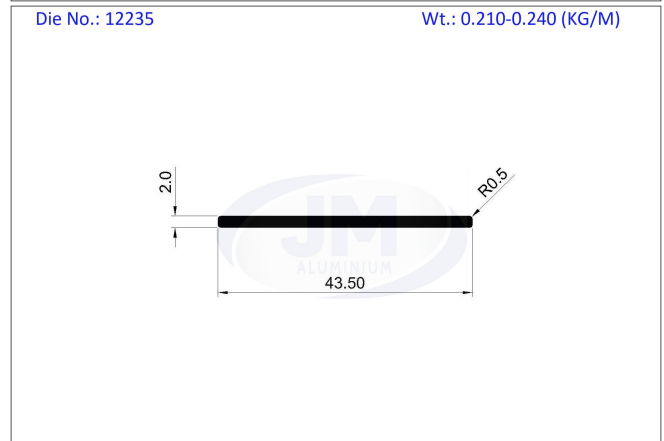
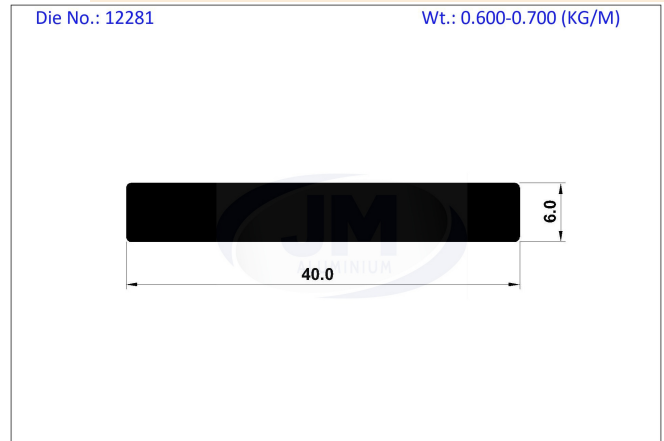

**GEOMETRICAL SHAPES**

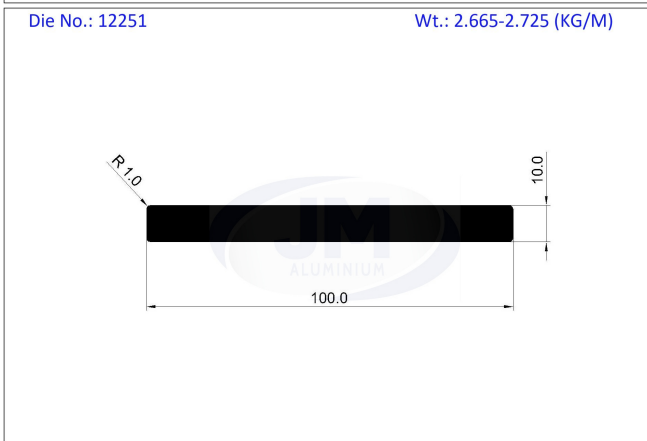
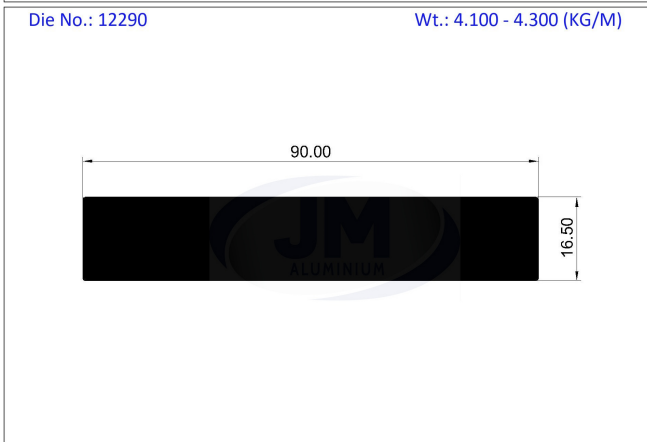
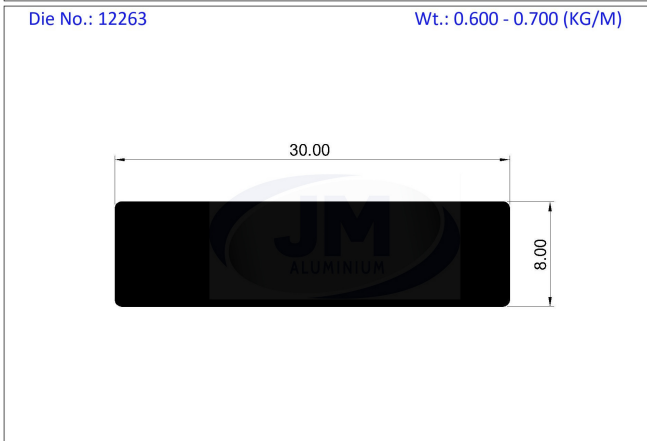
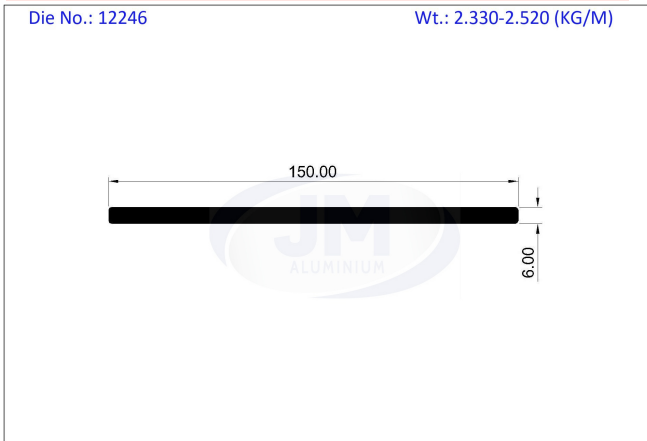

**Flat Bar**

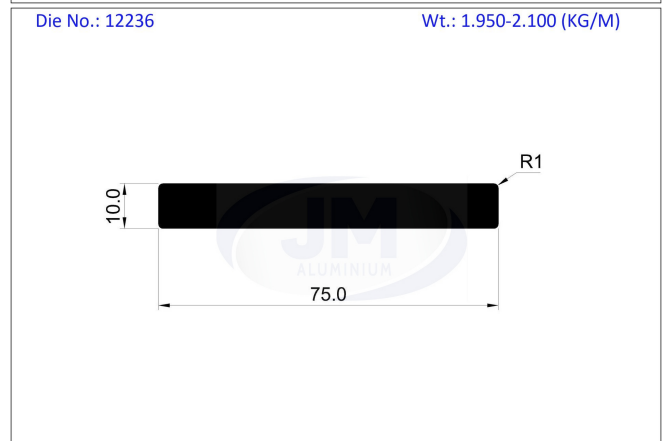
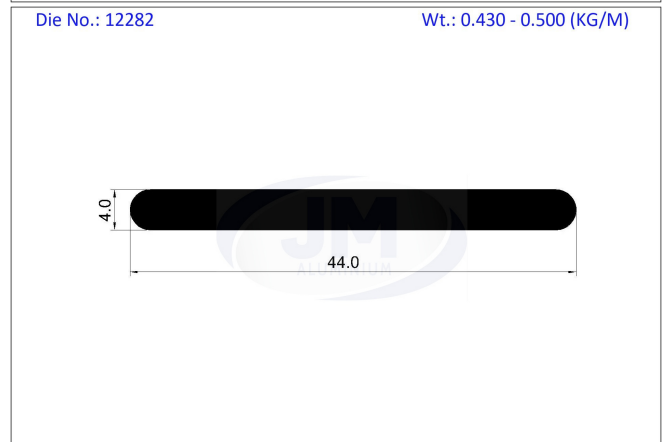
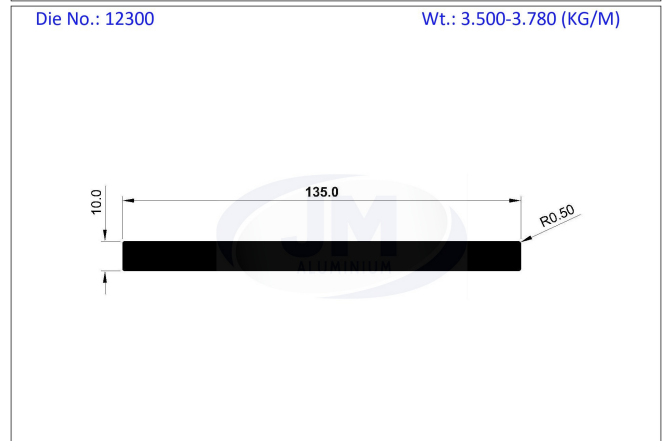
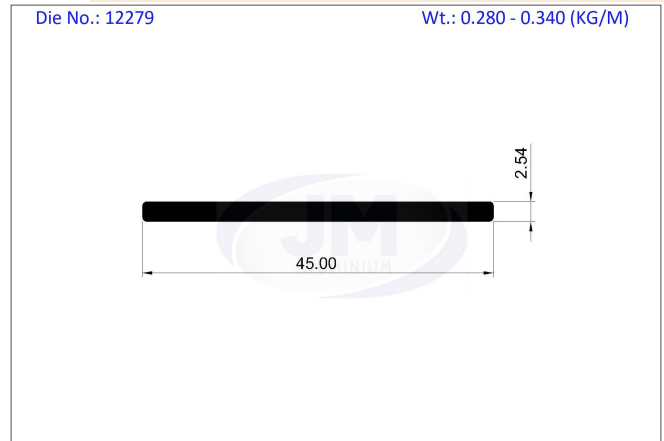

**GEOMETRICAL SHAPES**

**Flat Bar**

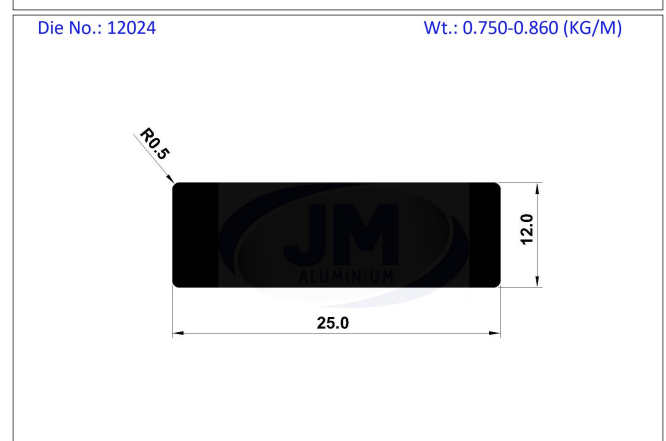
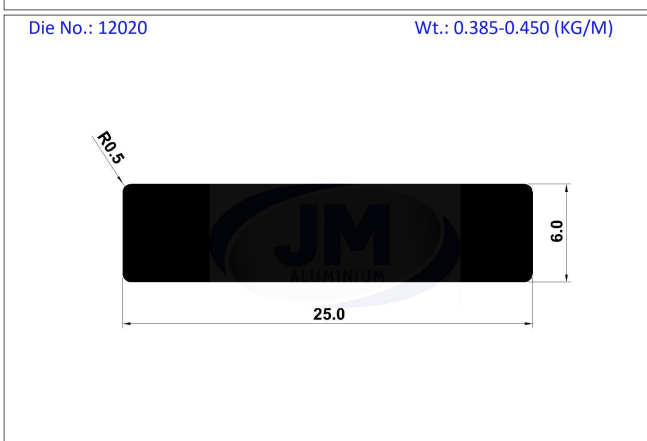
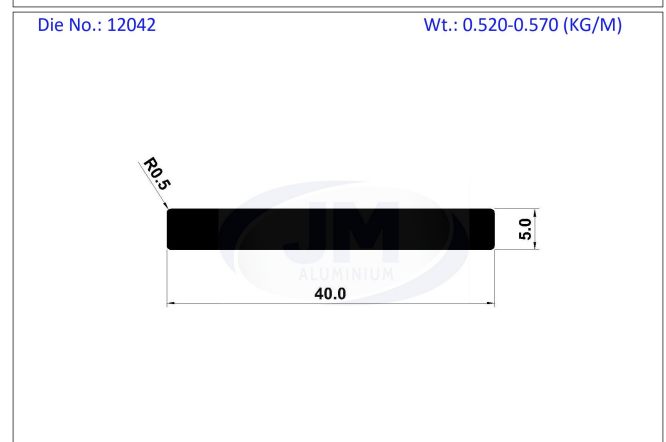
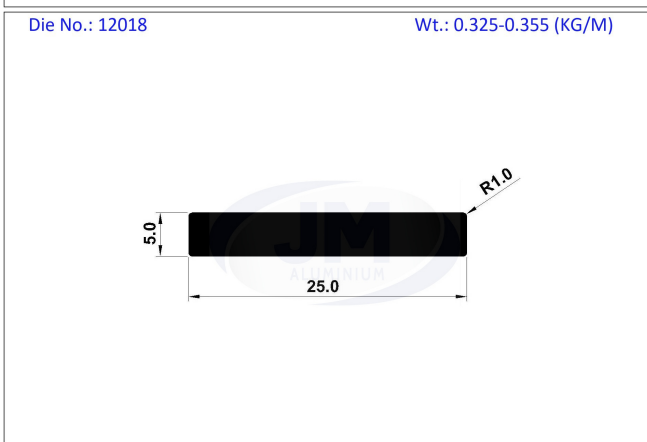
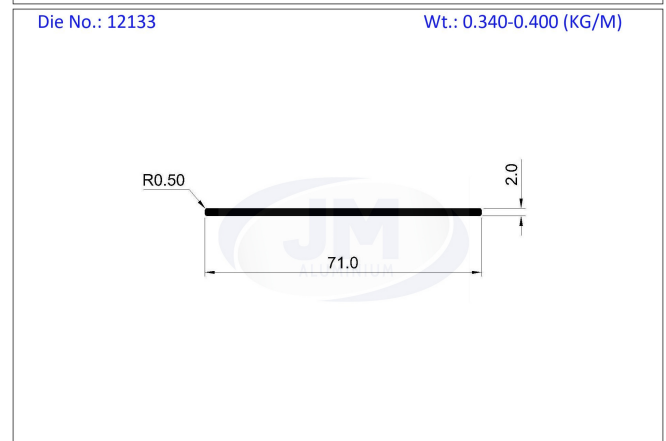
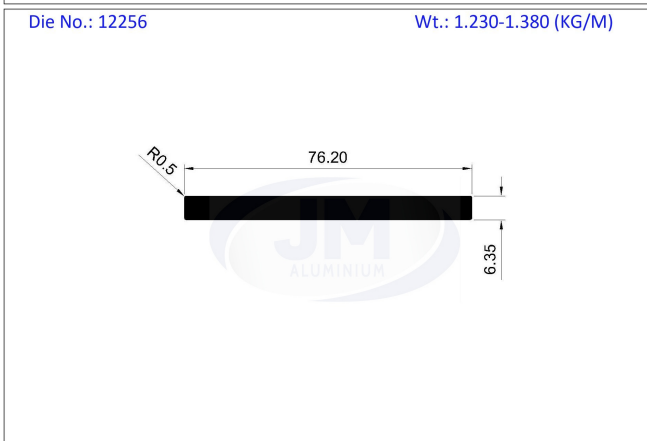
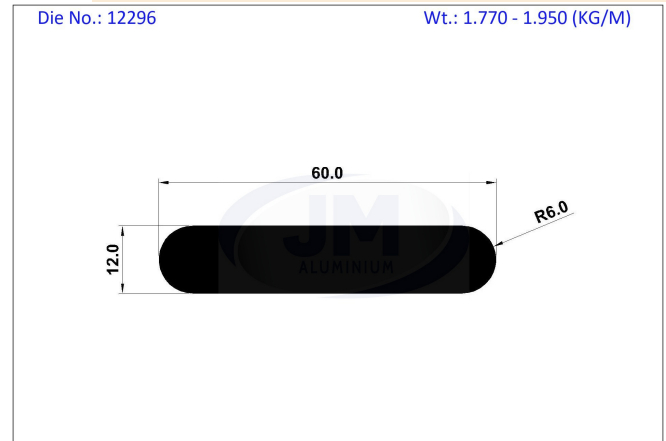
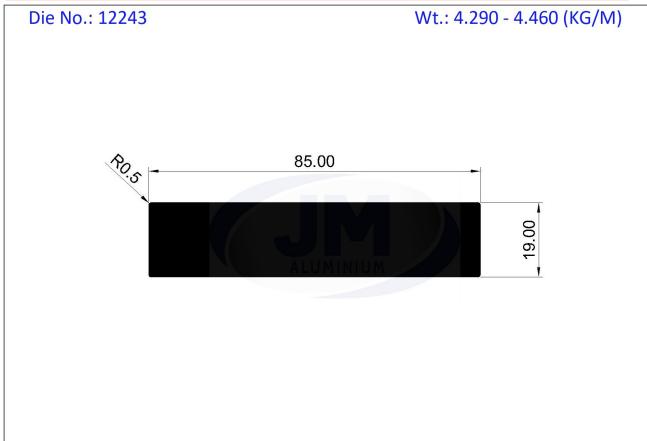

**GEOMETRICAL SHAPES**

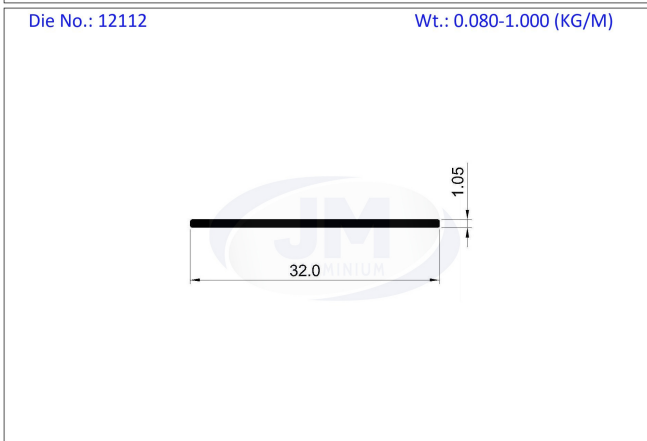
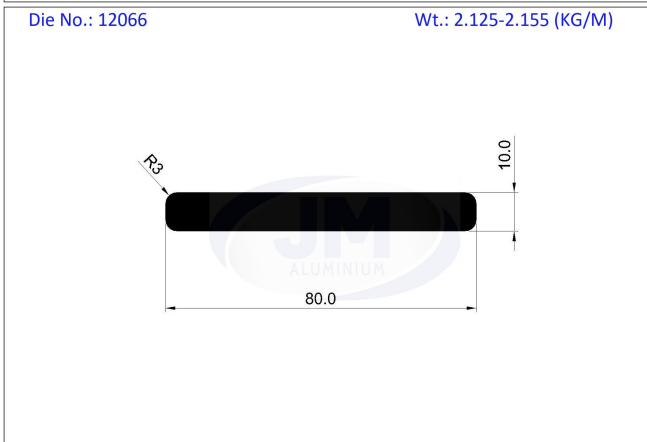
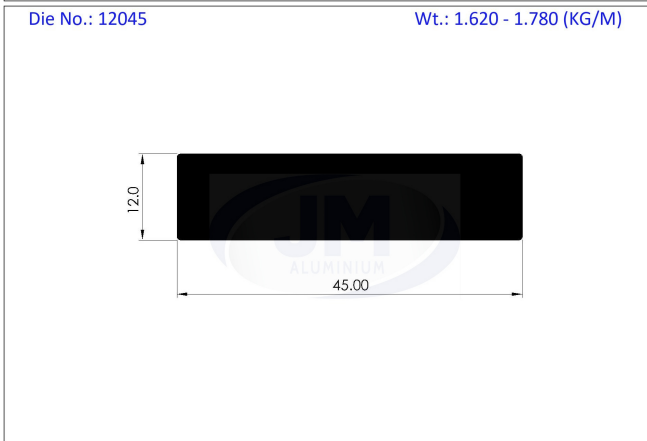
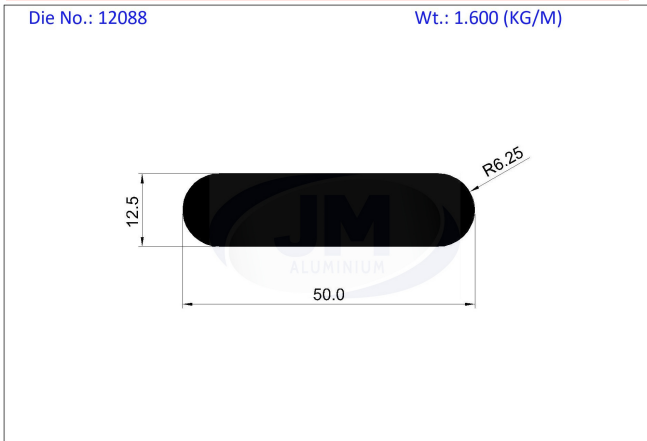

**Flat Bar**

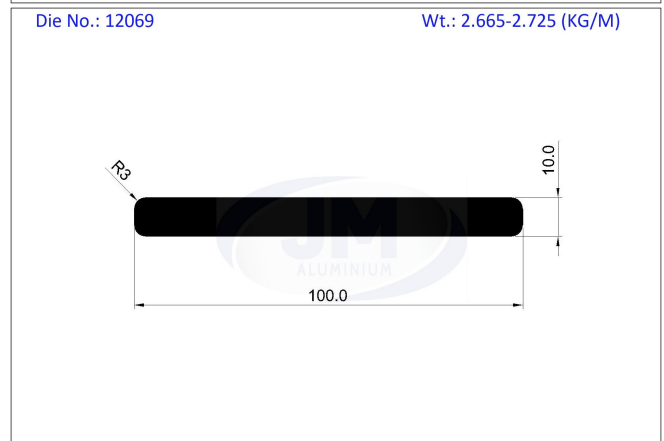
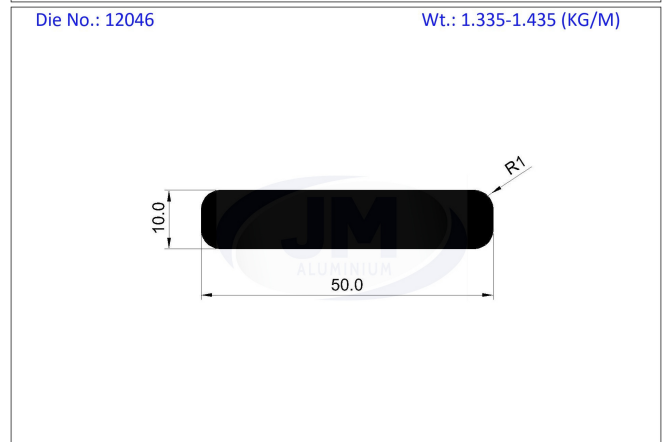
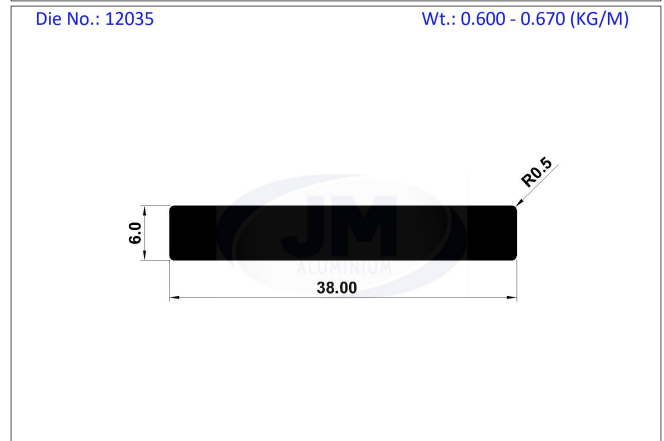
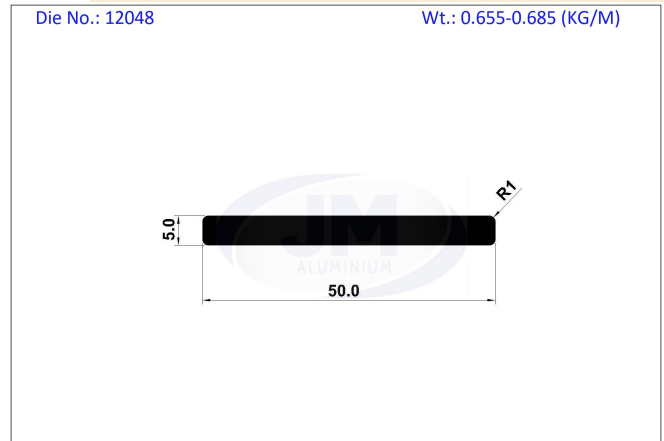

**GEOMETRICAL SHAPES**

**Flat Bar**

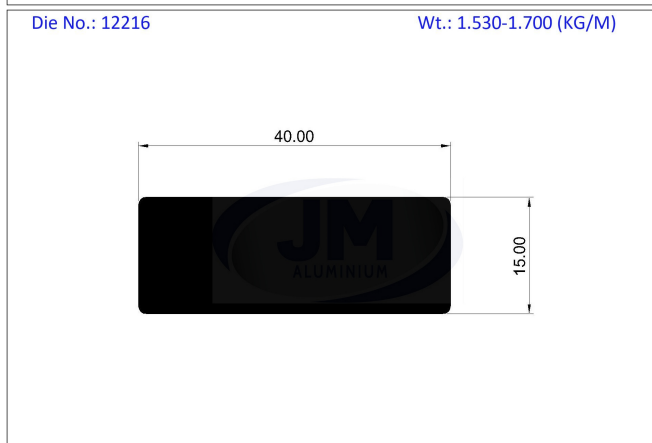
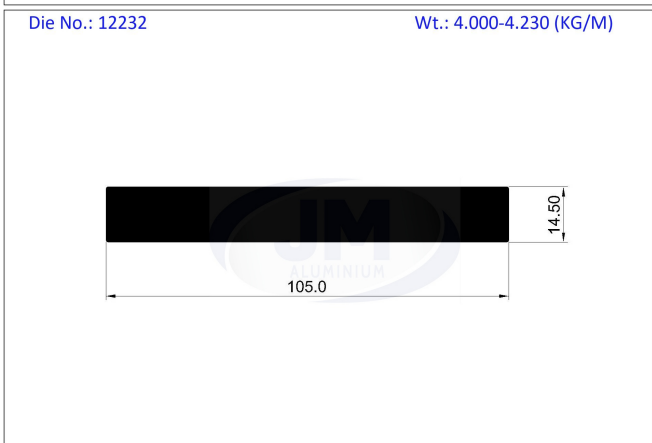
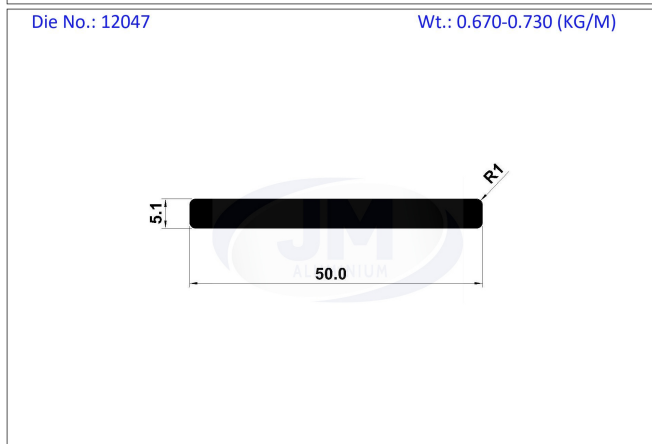
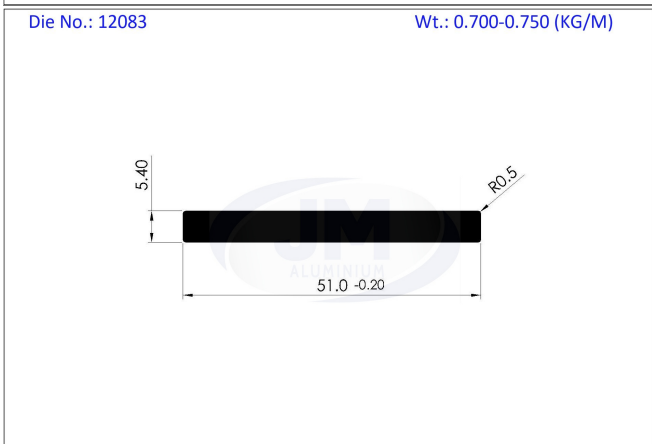
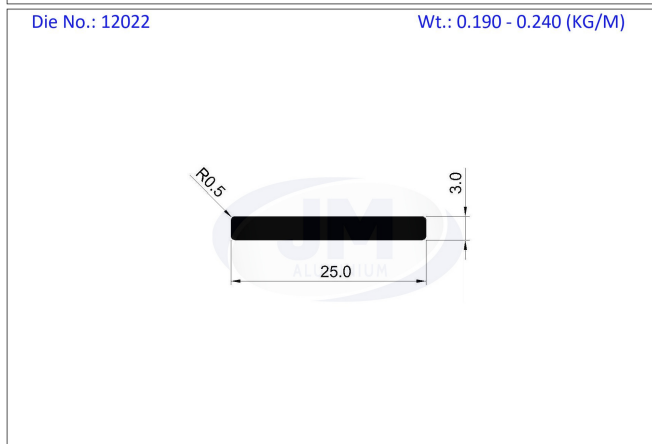
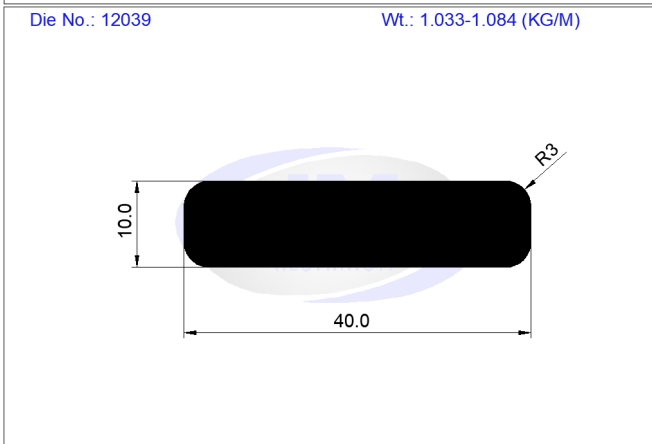
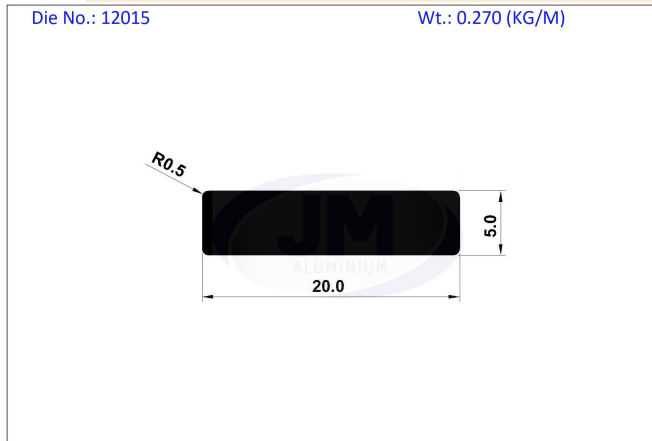
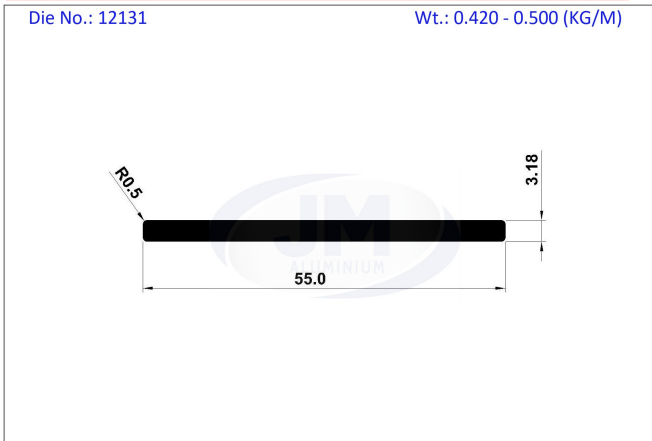

**GEOMETRICAL SHAPES**

**Flat Bar**

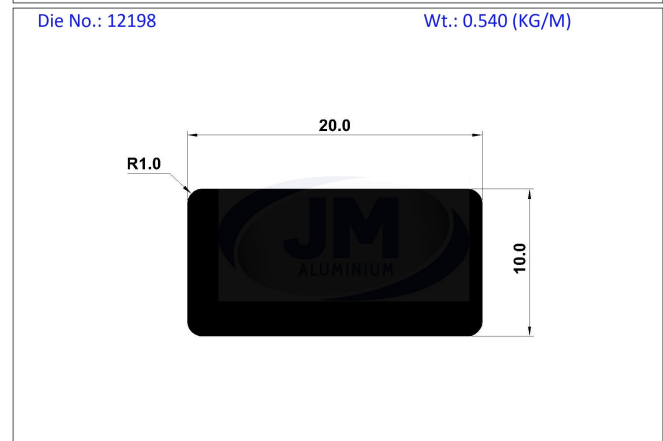
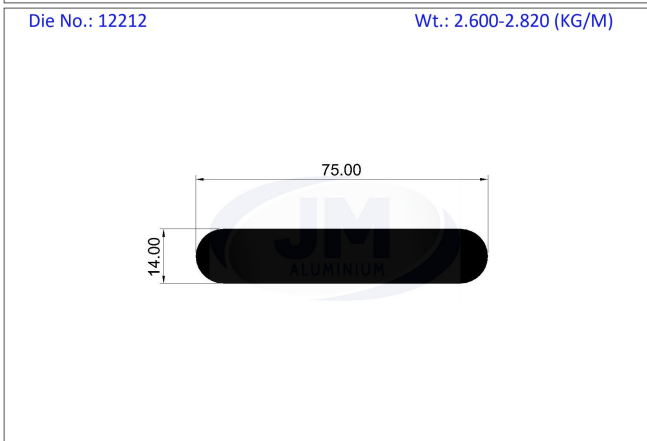
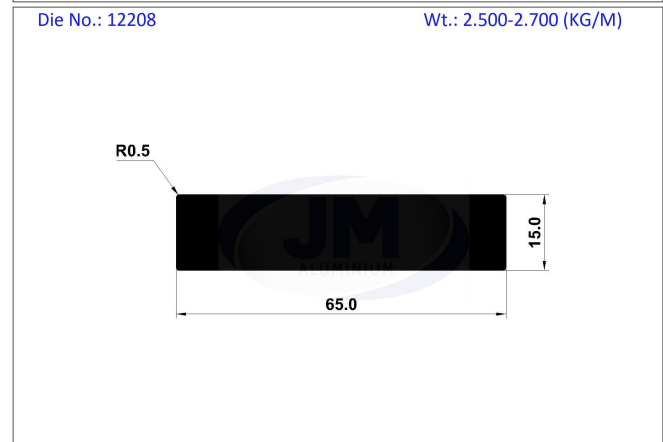
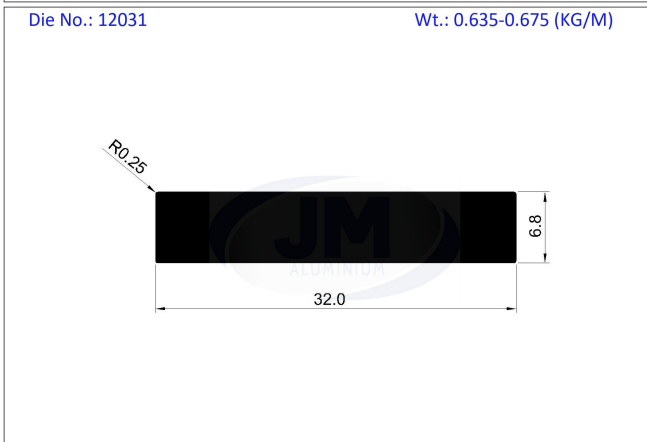
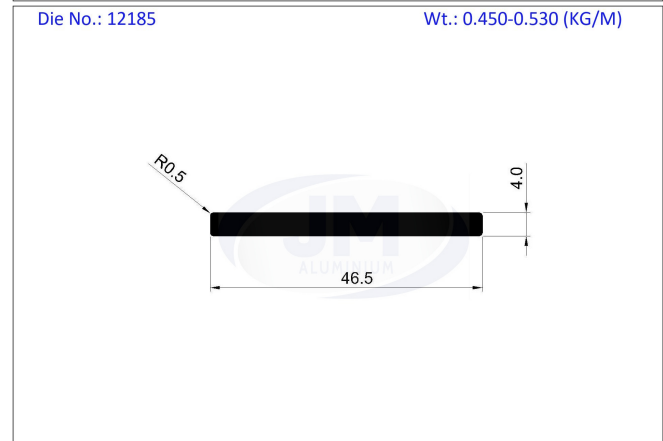
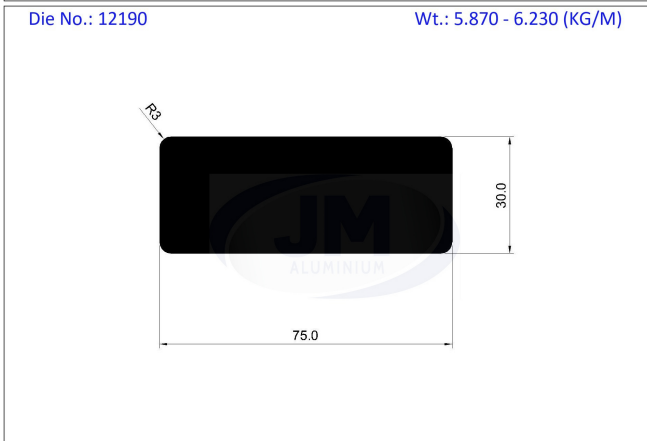
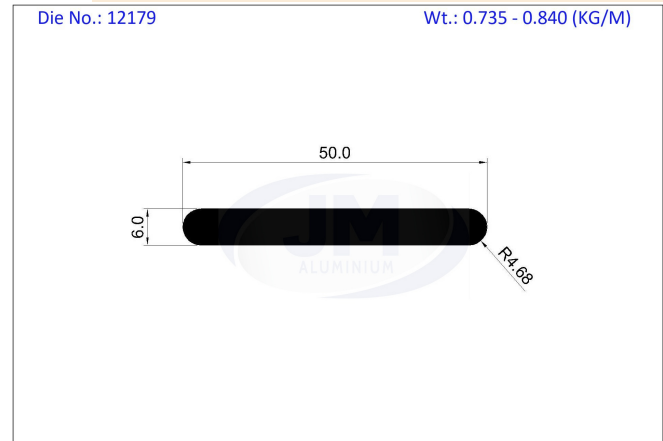
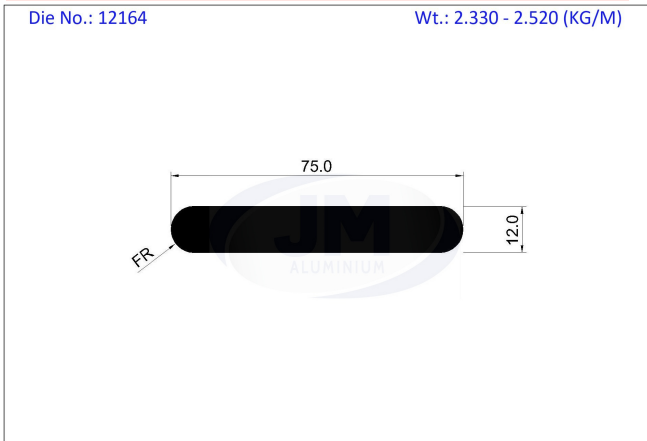

**GEOMETRICAL SHAPES**

**Flat Bar**

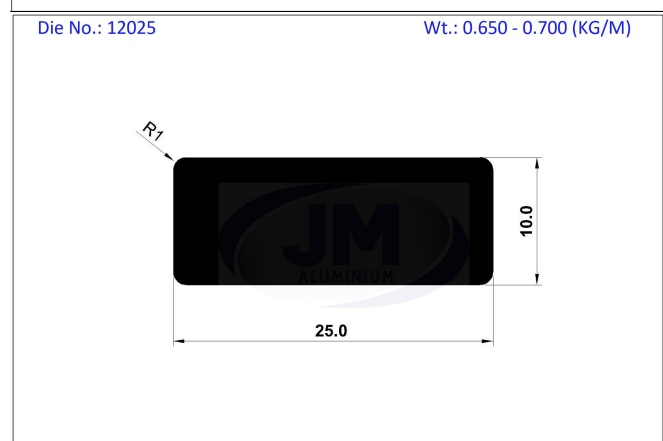
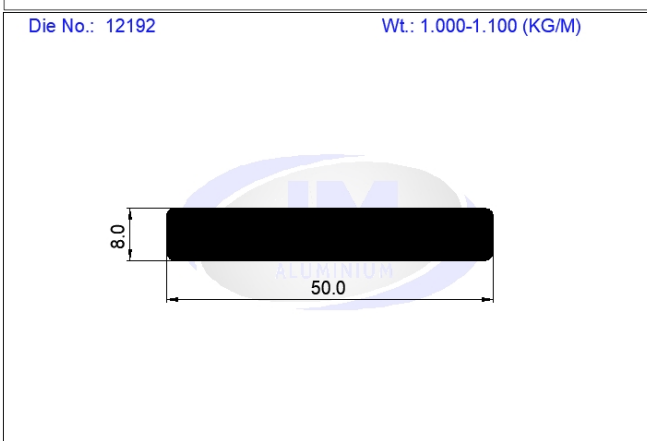
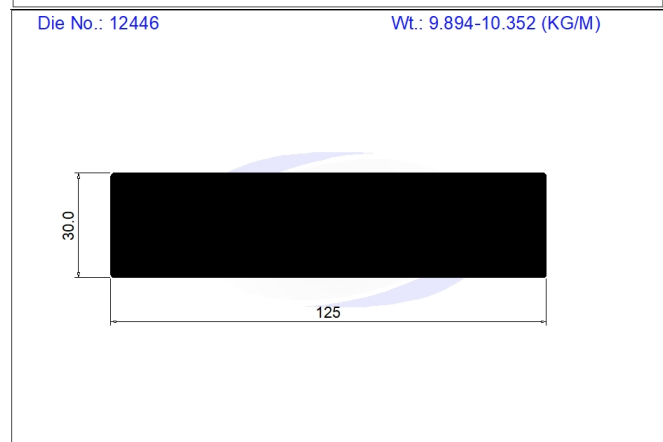
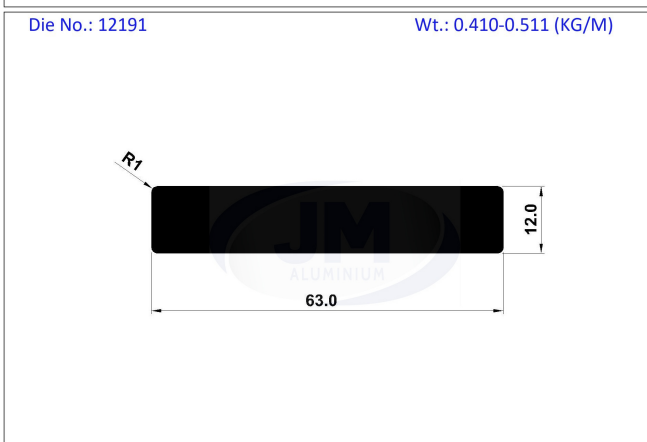
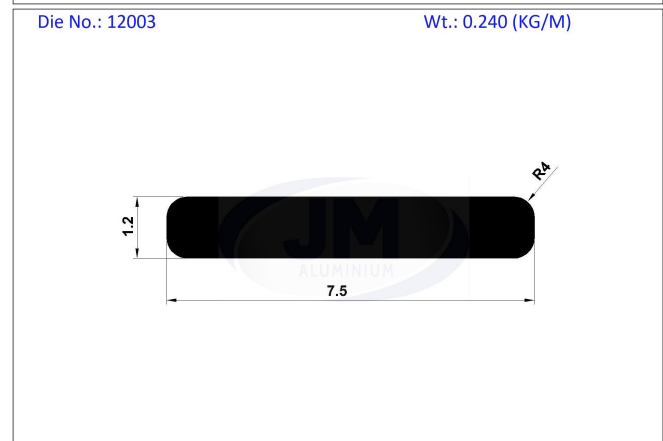
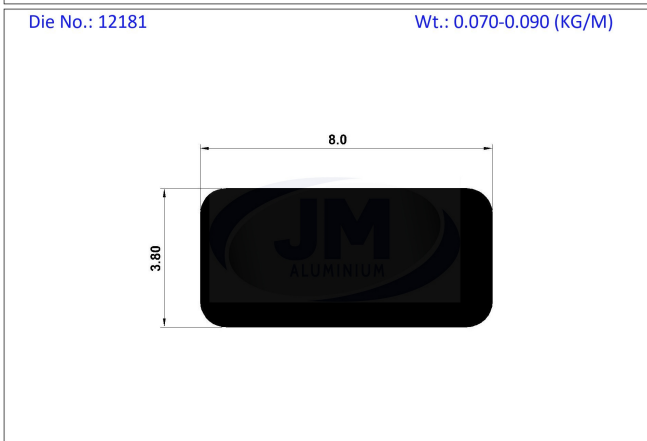
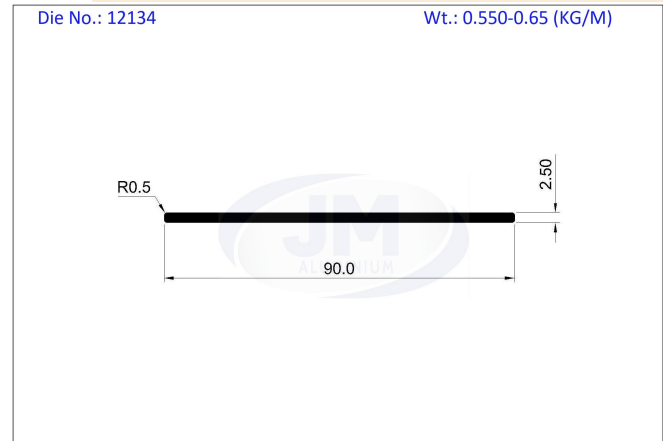
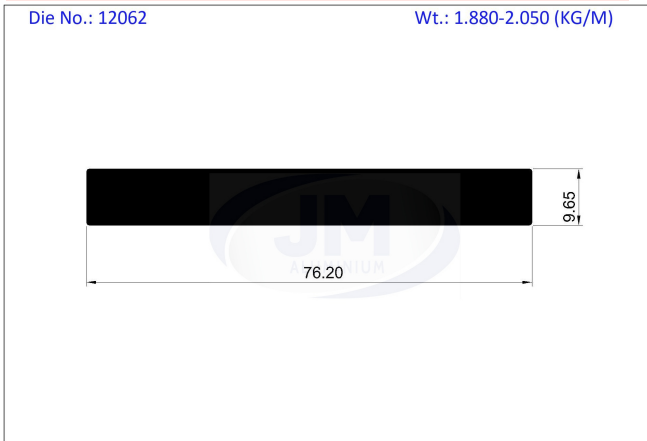

**GEOMETRICAL SHAPES**

**Flat Bar**

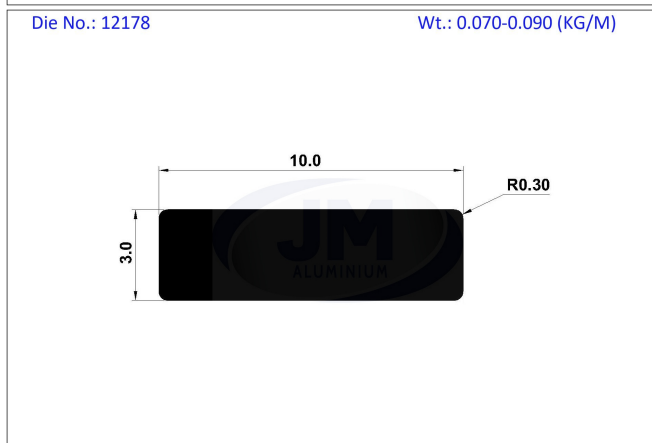
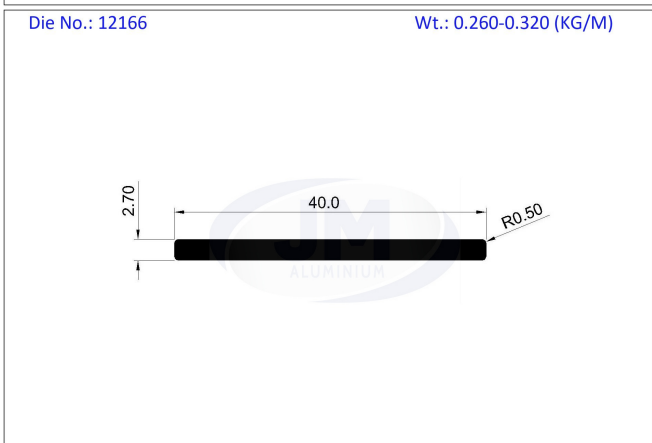
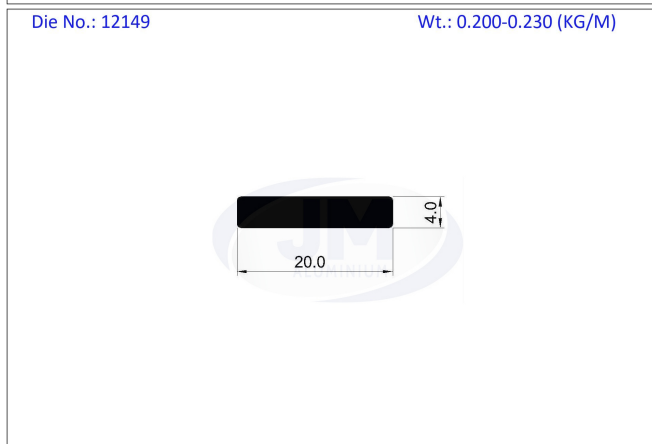
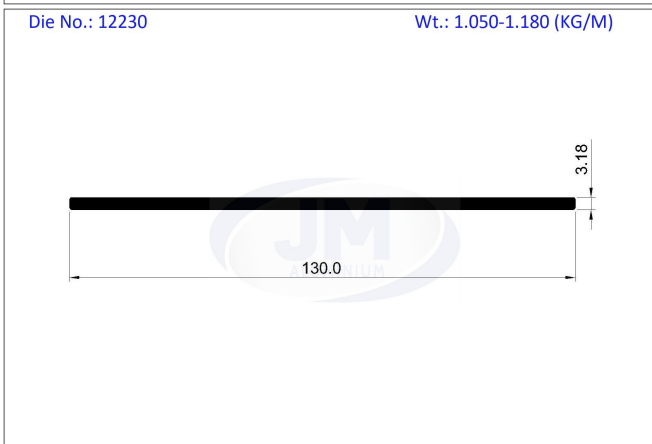
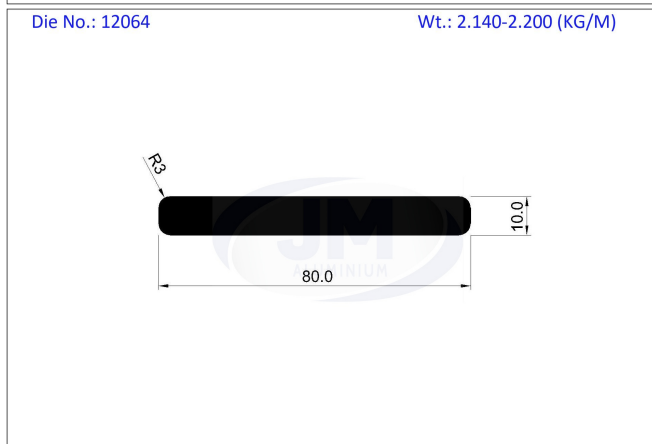
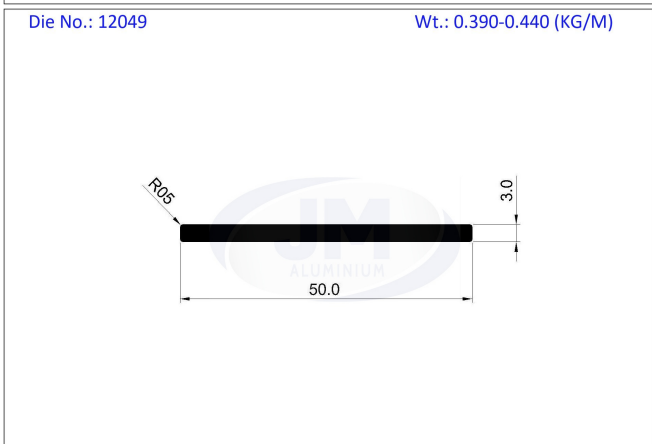
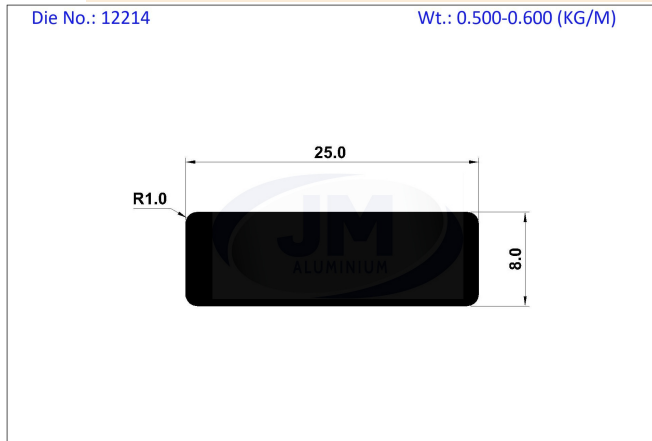
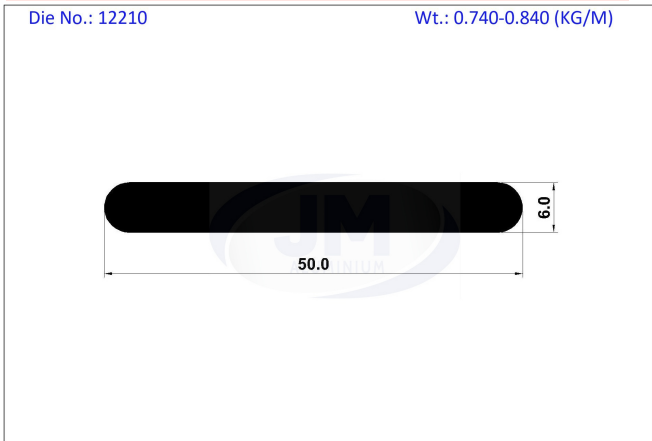



**GEOMETRICAL SHAPES**

**Flat Bar**

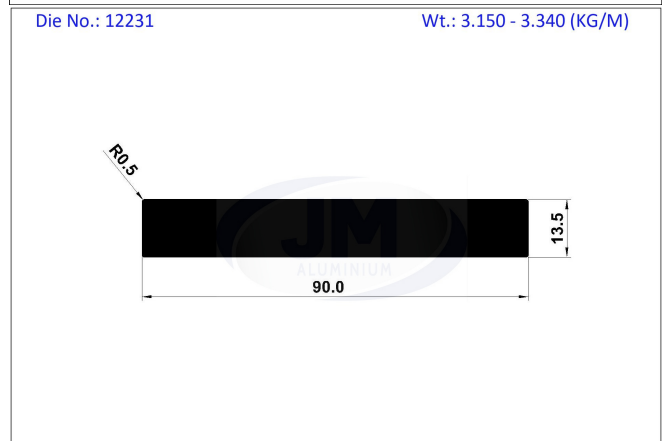
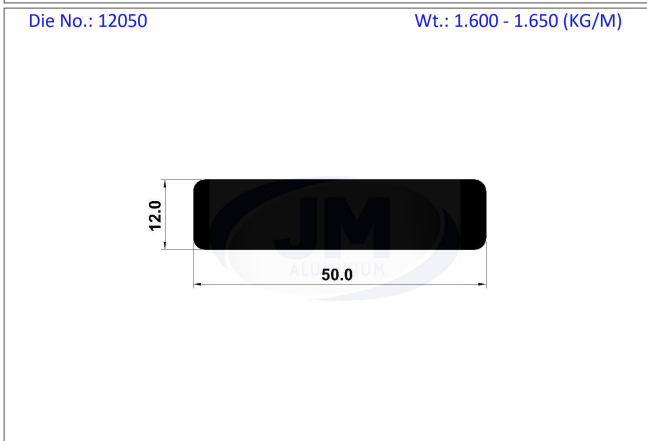
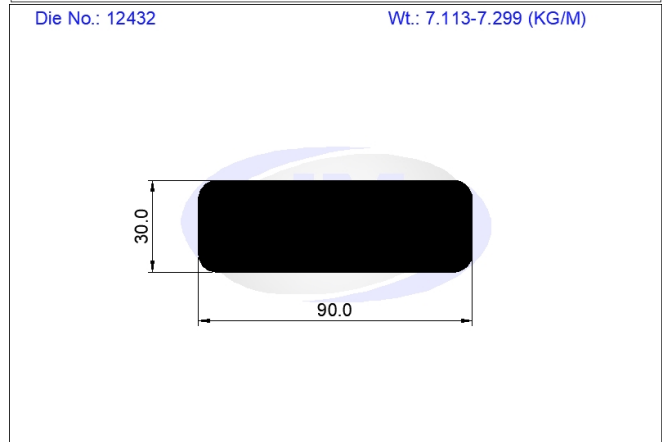
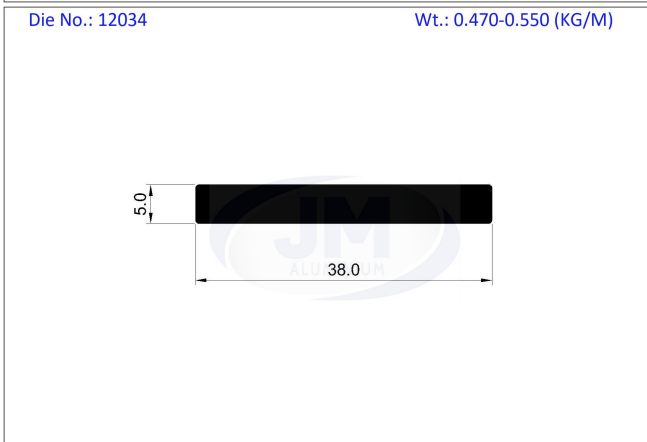
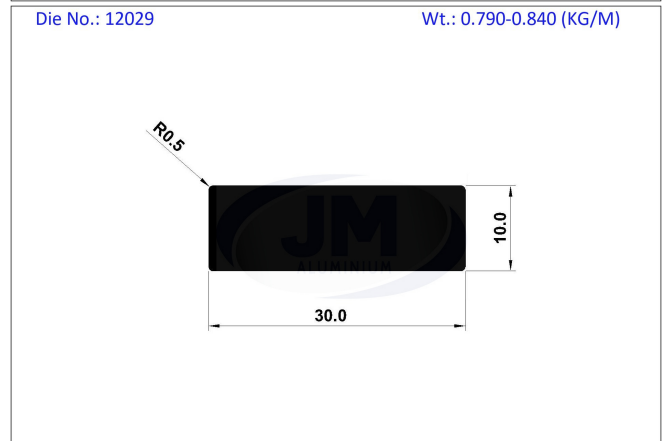
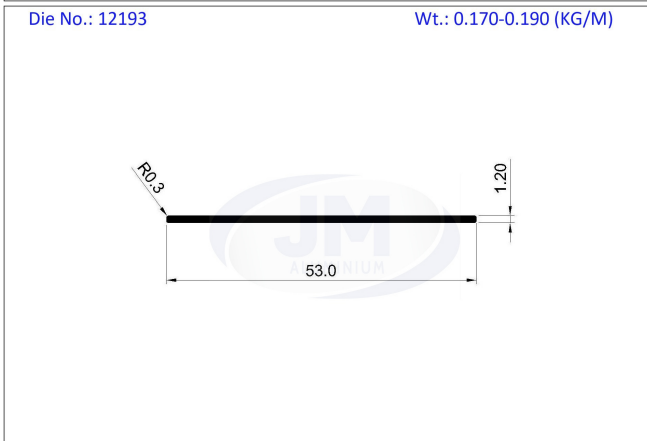
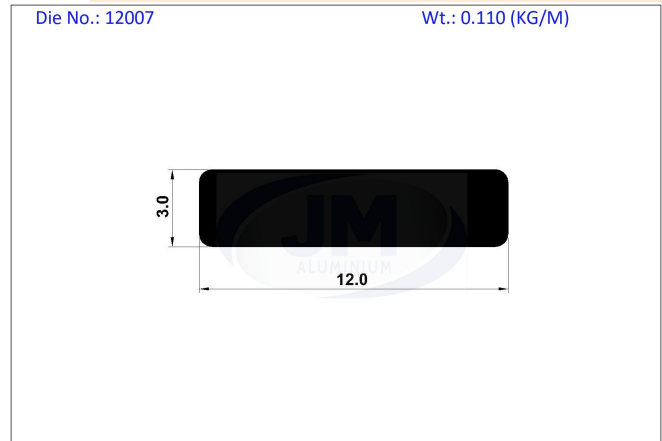
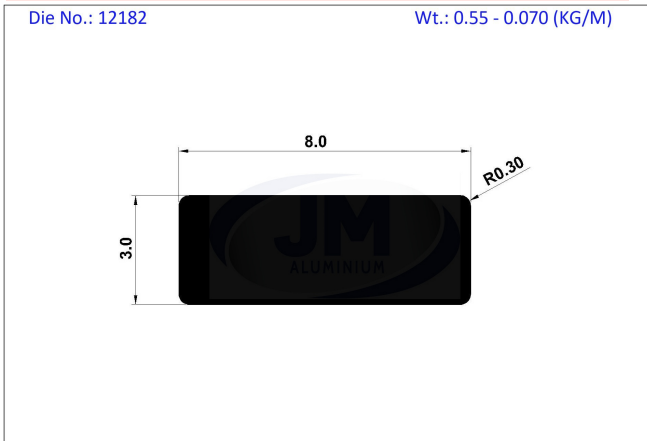

**GEOMETRICAL SHAPES**

**Flat Bar**

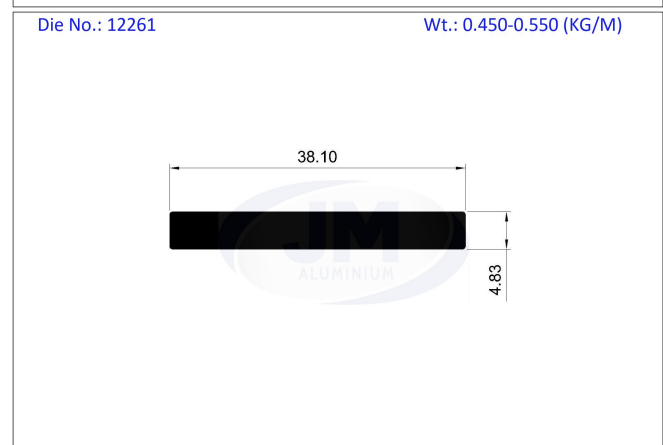
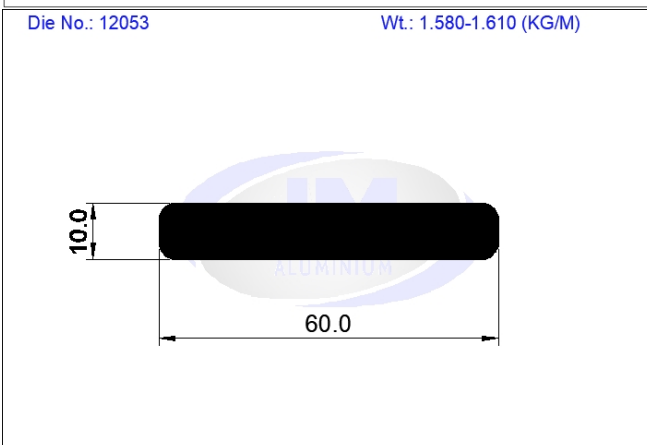
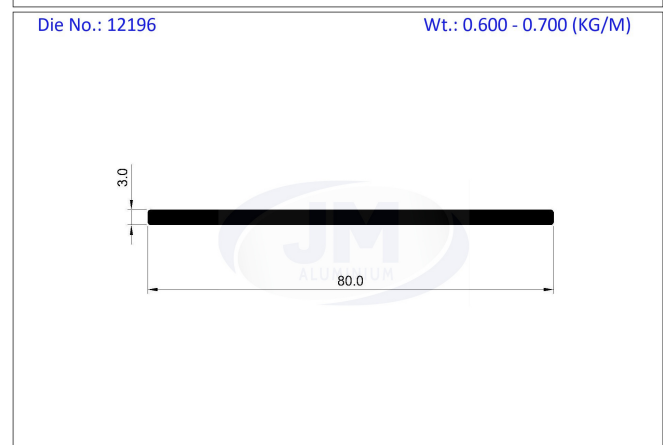
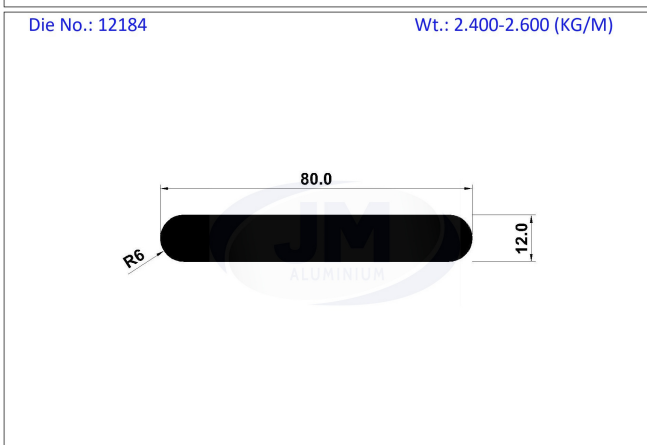
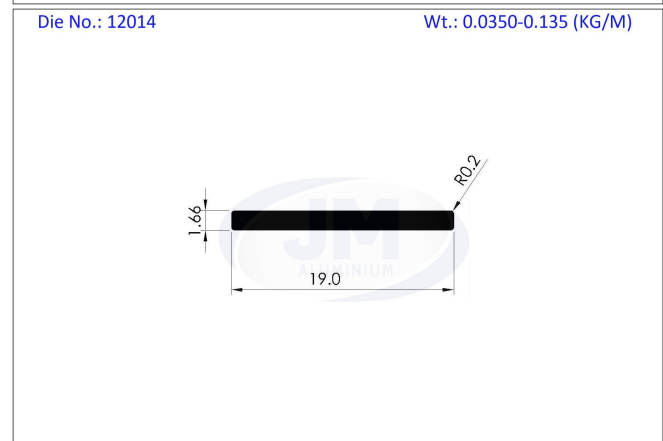
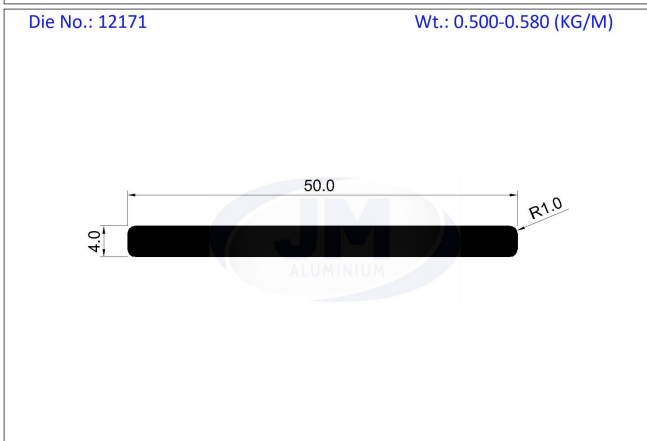
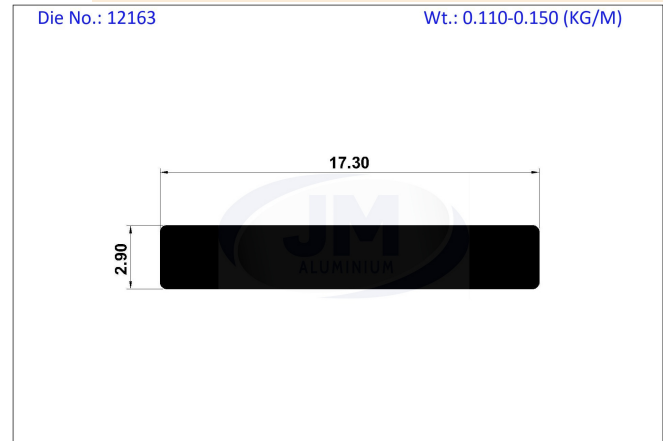
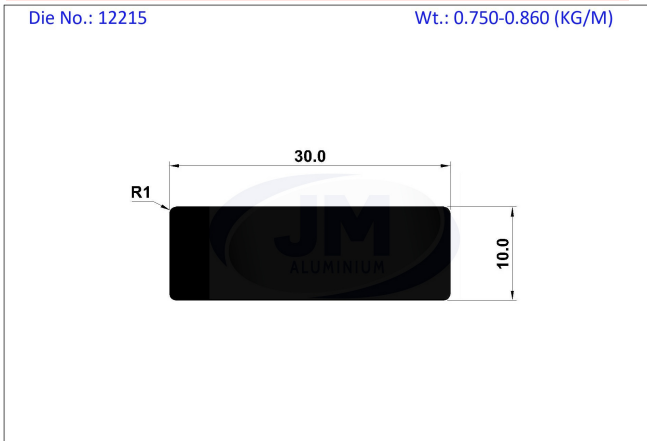

**GEOMETRICAL SHAPES**

**Flat Bar**

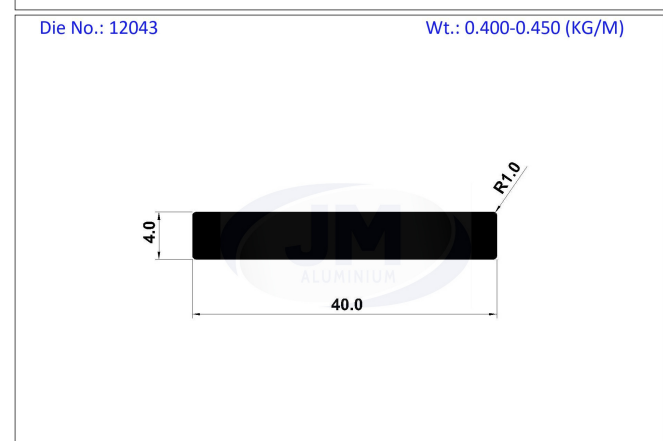
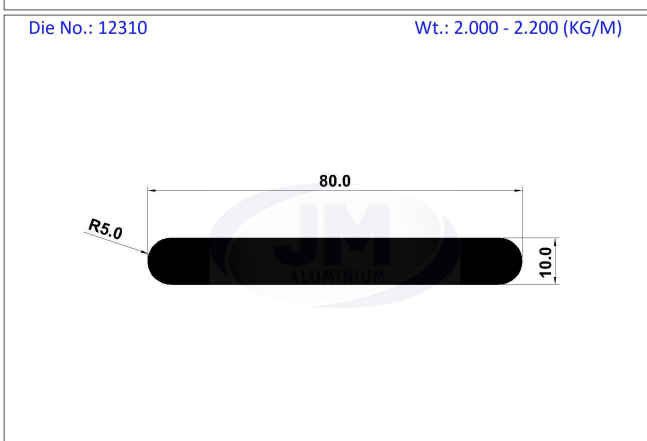
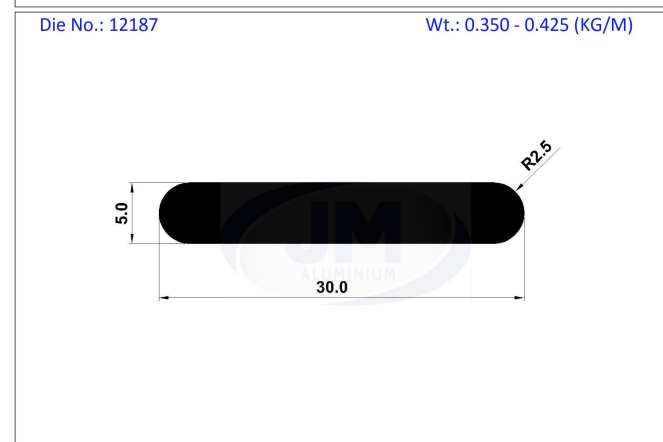
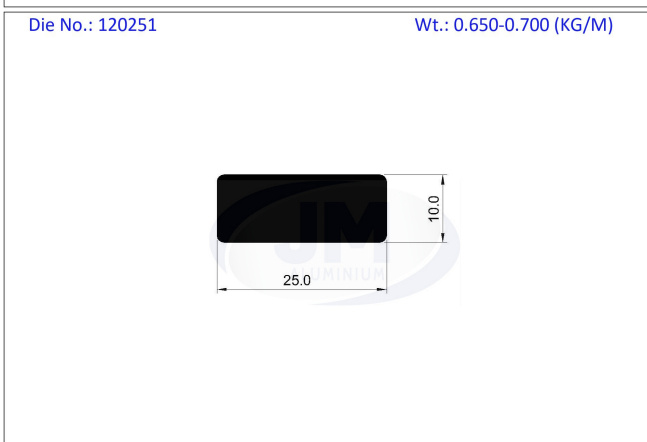
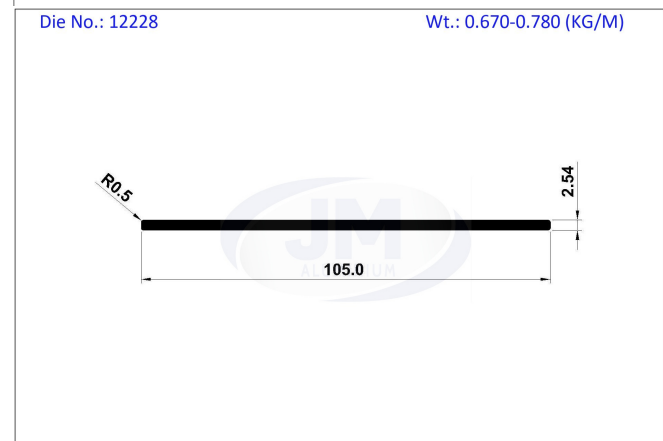
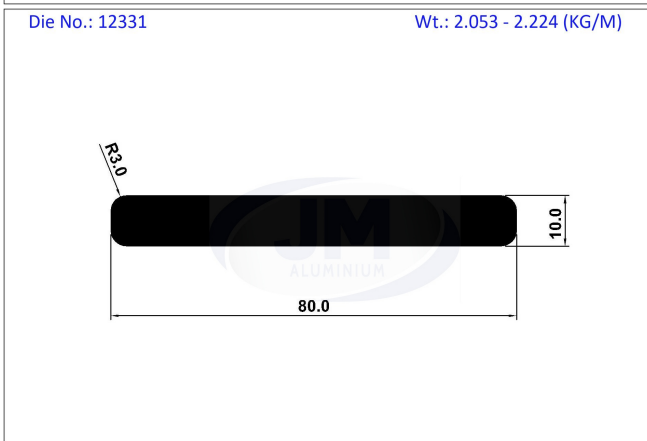
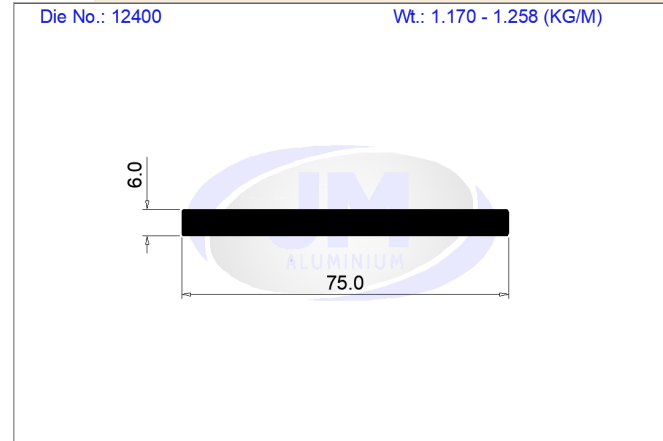
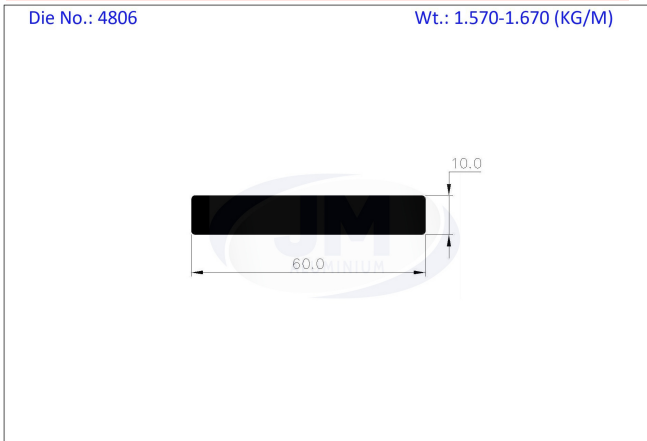

**GEOMETRICAL SHAPES**

**Flat Bar**

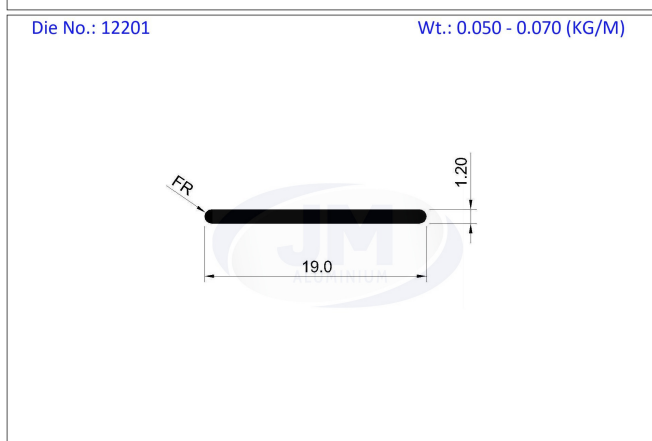
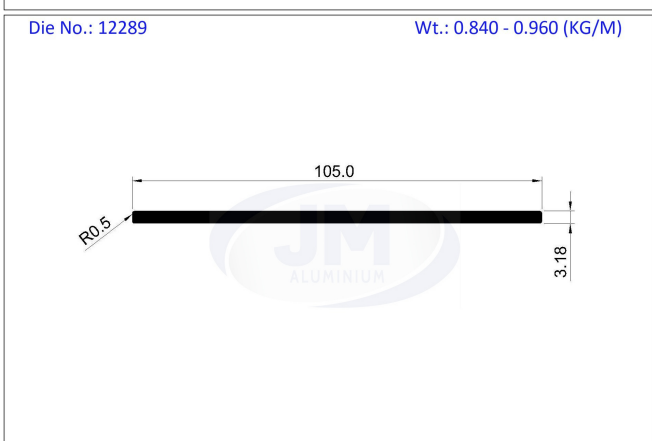
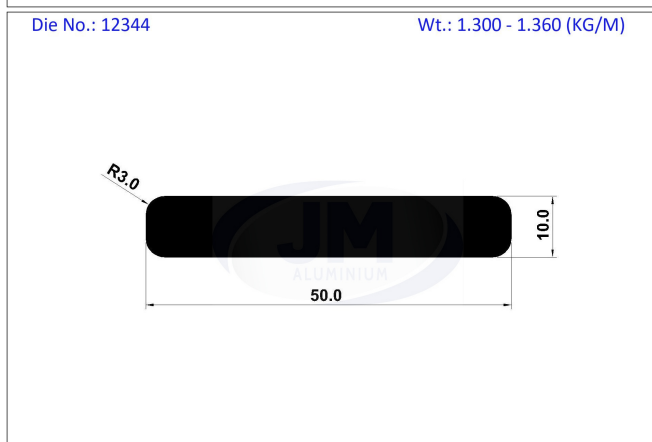
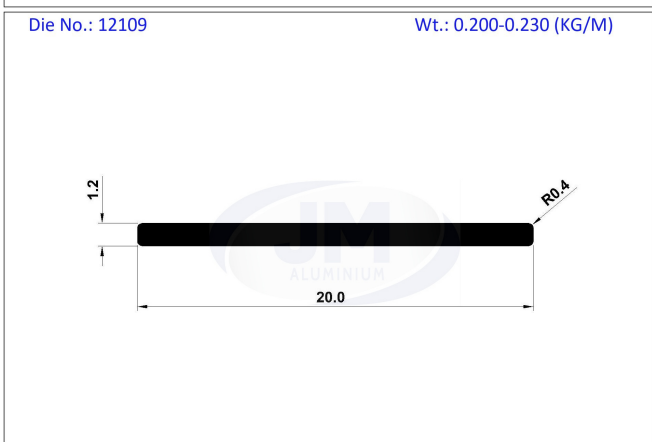
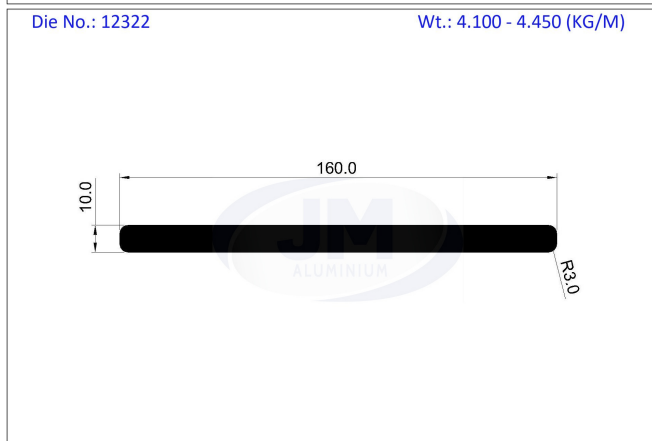
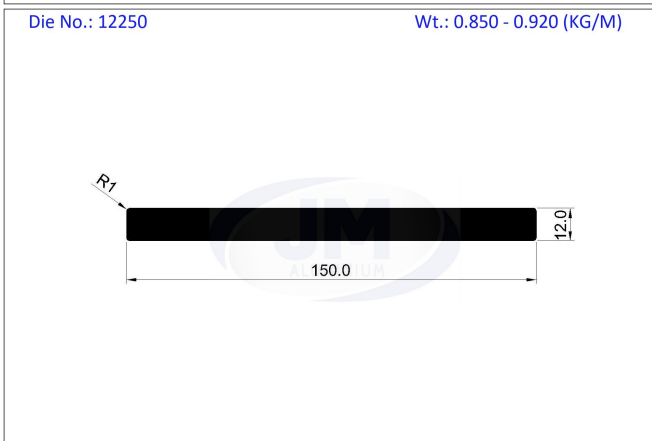
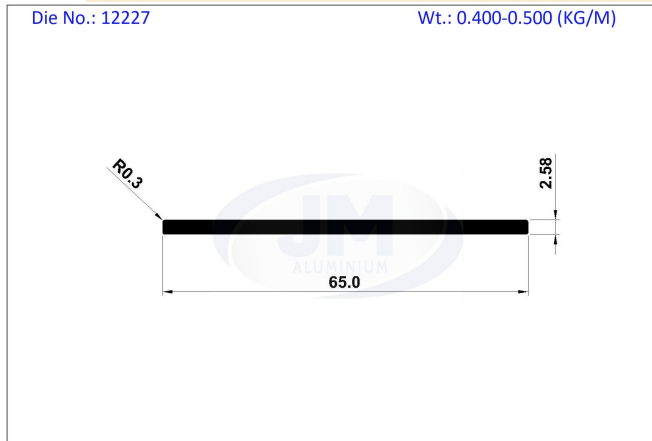
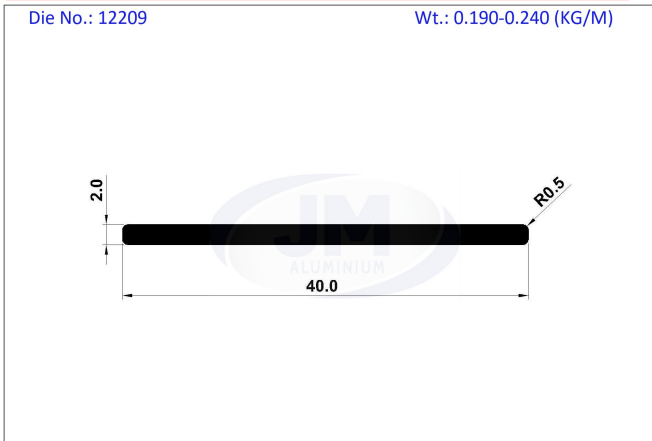

**GEOMETRICAL SHAPES**

**Flat Bar**

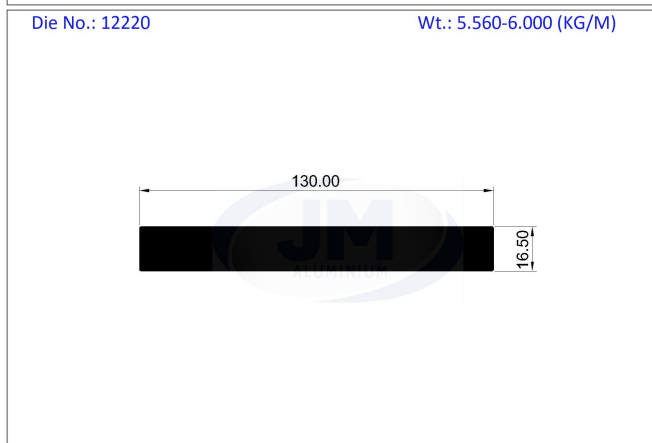
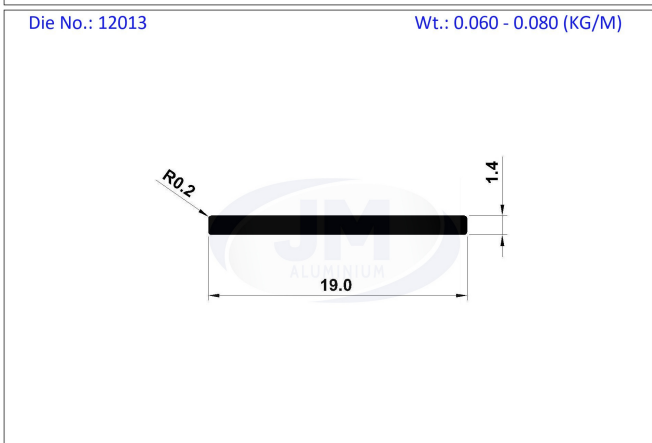
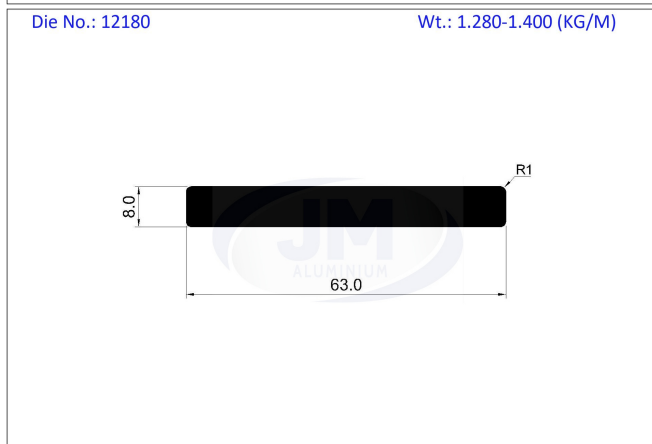
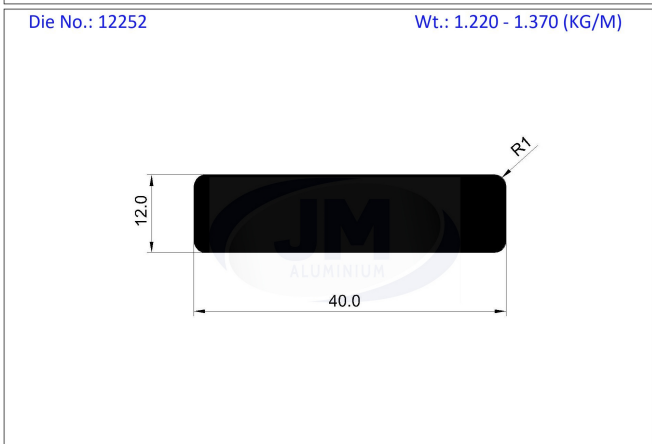
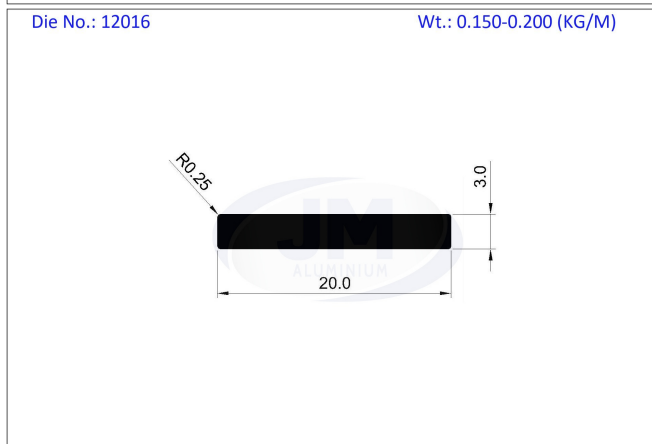
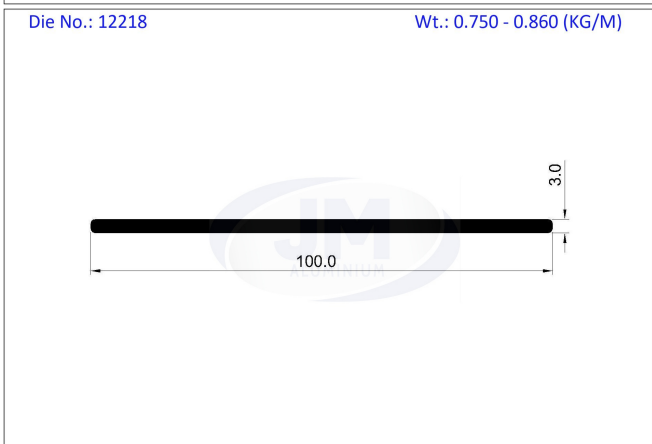
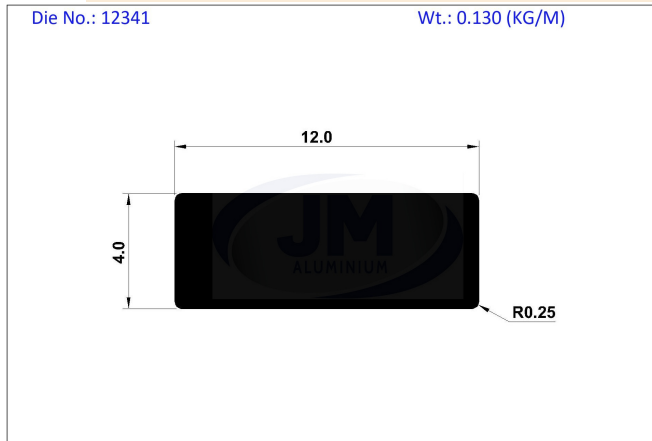
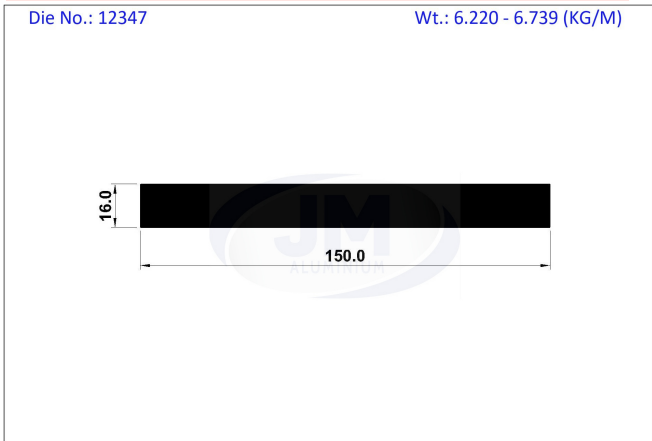

**GEOMETRICAL SHAPES**

**Flat Bar**

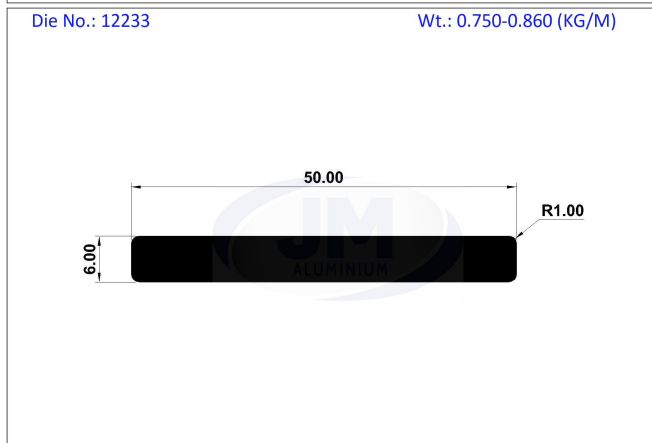
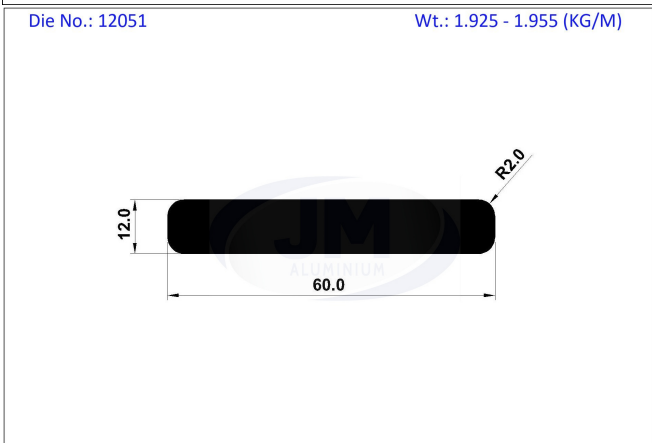
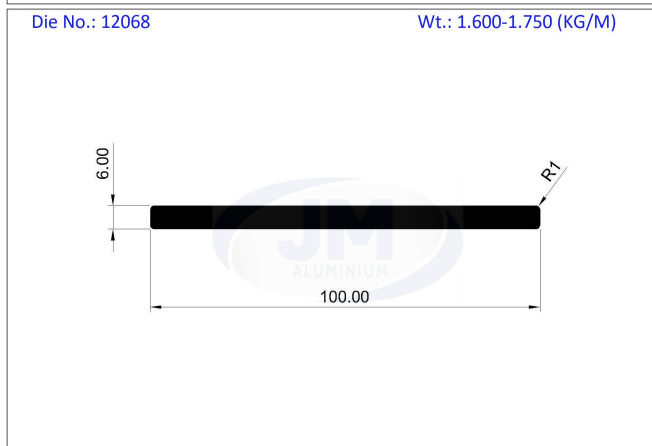
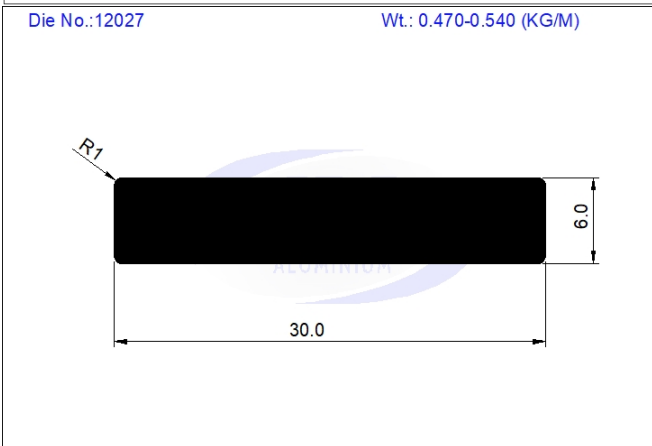
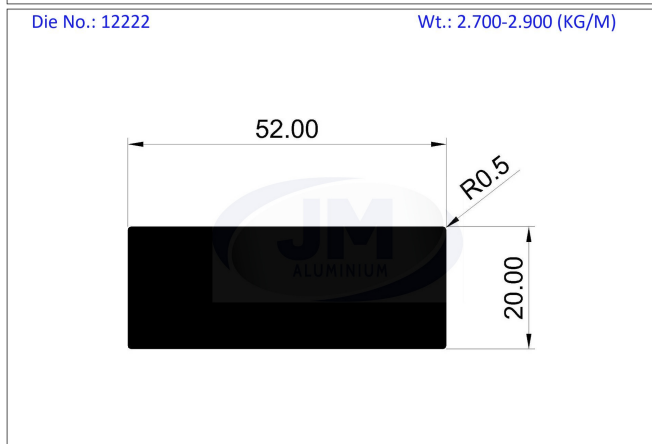
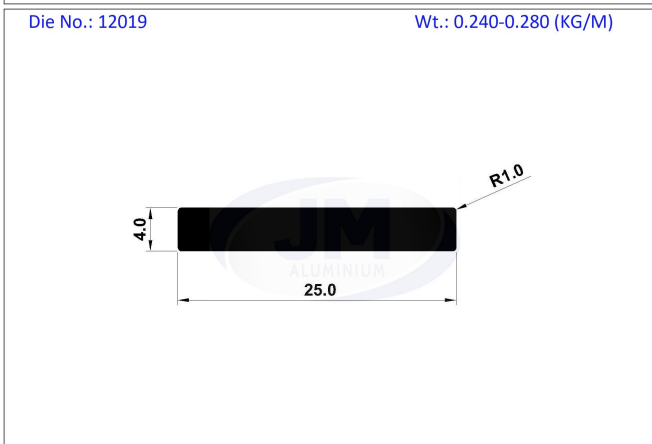
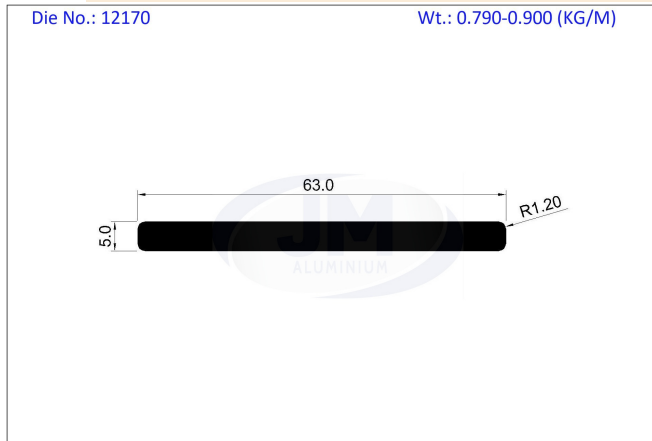
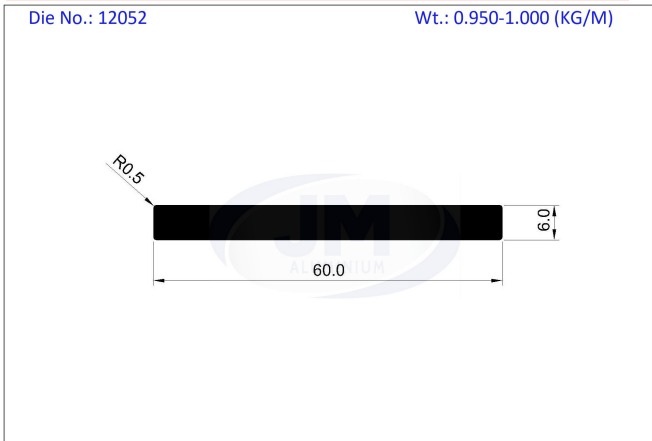

**GEOMETRICAL SHAPES**

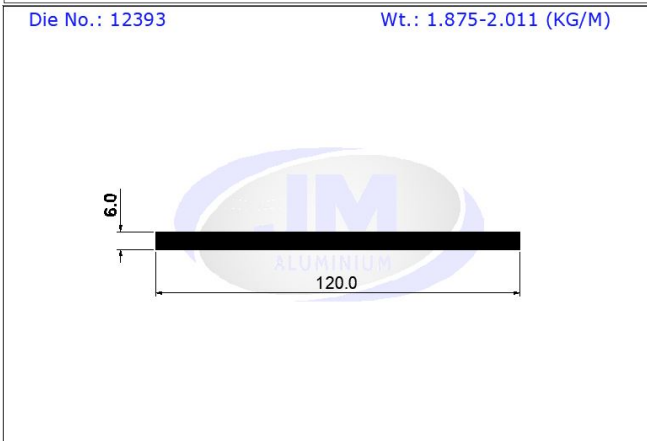
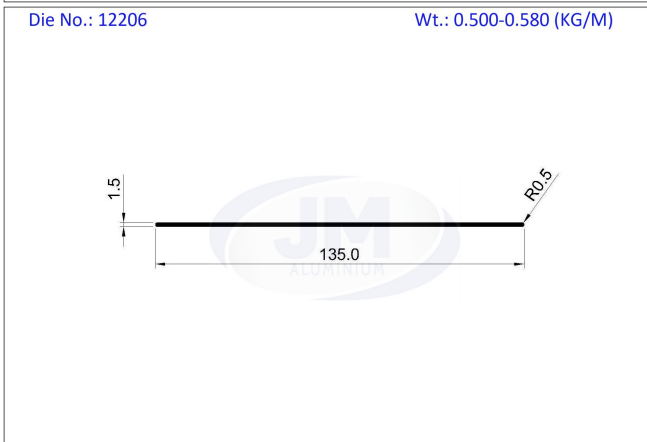
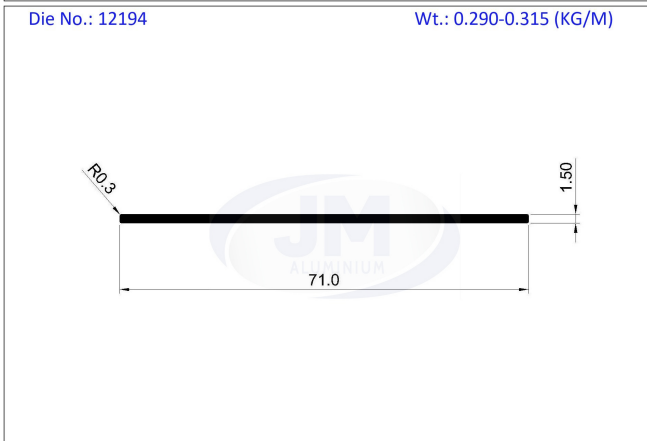
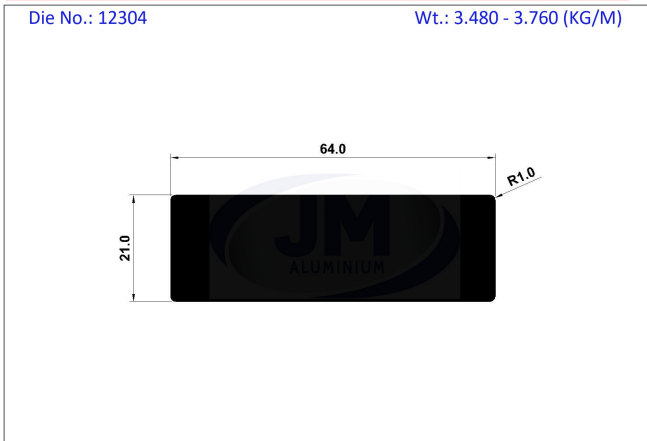

**Flat Bar**

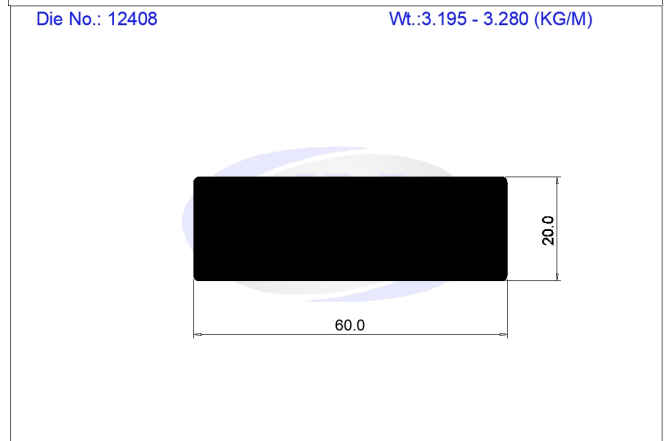
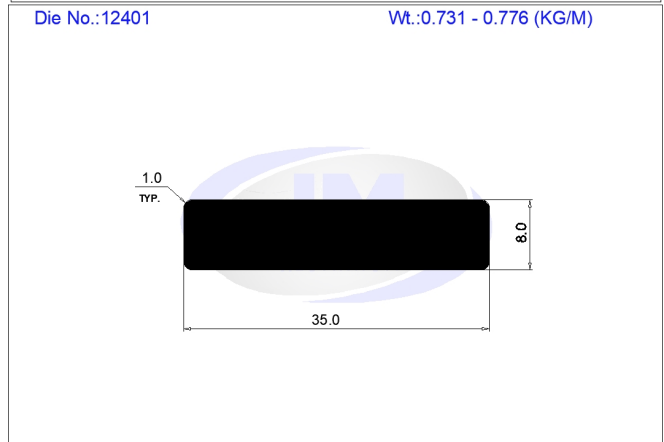
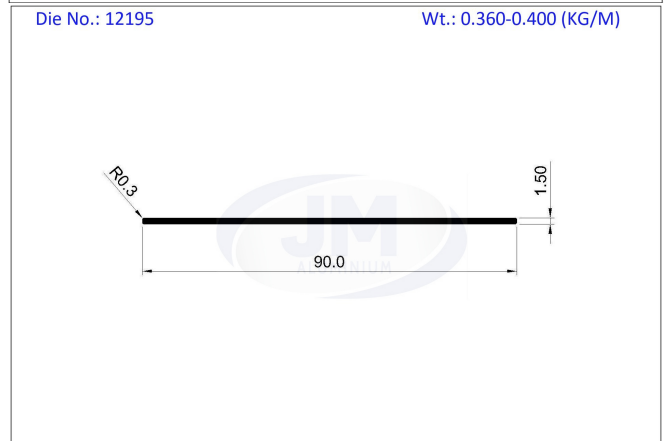
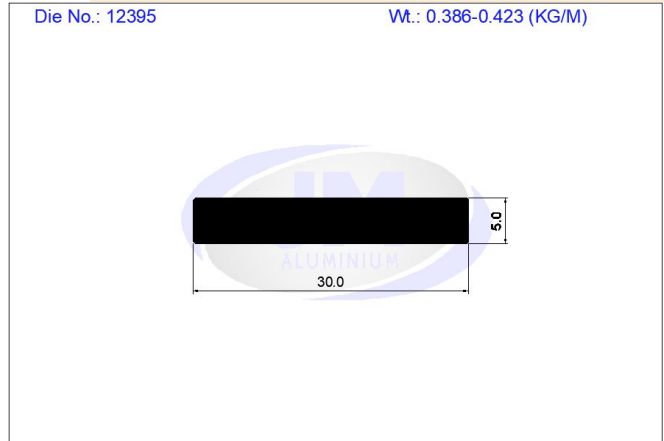

**GEOMETRICAL SHAPES**

Die No.: 12409	Wt.:0.300 - 0.346 (KG/M)
Die No.: 12407	Wt.:8.021-8.178 (KG/M)
Die No.: 12418	Wt.: 5.426-5.588 (KG/M)
Die No.: 12411	Wt.: 2.507-2.676 (KG/M)

**Flat Bar**

Die No.: 12406	Wt.:3.987-4.111 (KG/M)
Die No.: 12417	Wt.: 6.025-6.204 (KG/M)
Die No.: 12385	Wt.: 0.325- 0.337 (KG/M)
Die No.: 12425	Wt.: 5.267-5.491 (KG/M)





**GEOMETRICAL SHAPES**

Die No.: 12426	Wt.: 4.738-4.940 (KG/M)
Die No.: 12437	Wt.: 0.466-0.505 (KG/M)
Die No.: 12447	Wt.: 9.204-9.585(KG/M)
Die No.: 12435	Wt.: 0.316-0.390 (KG/M)

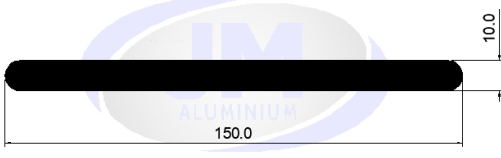
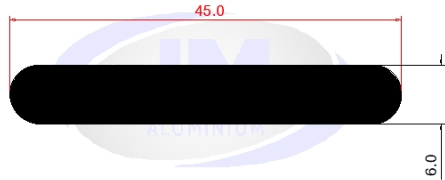

**Flat Bar**

Die No.: 12413	Wt.: 8.036-8.292 (KG/M)
Die No.: 12384	Wt.: 0.779 - 0.809 (KG/M)
Die No.: 12434	Wt.: 0.287-0.314 (KG/M)
Die No.: 12442	Wt.: 12.046-12.413 (KG/M)

**GEOMETRICAL SHAPES**

Die No.: 12433	Wt.: 3.908-4.076 (KG/M)
	
Die No.: 12450	Wt.: 0.675-0.740 (KG/M)
	
Die No.: 12456	Wt.: 0.137-0.169 (KG/M)
	
Die No.: 12476	Wt.: 5.460 - 5.876 (KG/M)
	

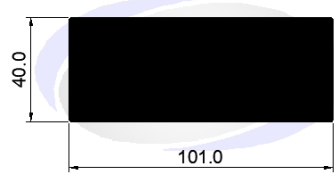
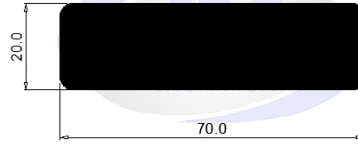
**Flat Bar**

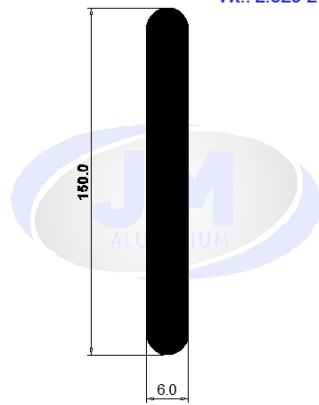
Die No.: 12438	Wt.: 10.773-11.038 (KG/M)
	
Die No.: 12458	Wt.: 3.712 - 3.806 (KG/M)
	
Die No.: 12455	Wt.: 0.325-0.357 (KG/M)
	
Die No.: 12485	Wt.: 2.326-2.492 (KG/M)
	

**GEOMETRICAL SHAPES**

**Flat Bar**

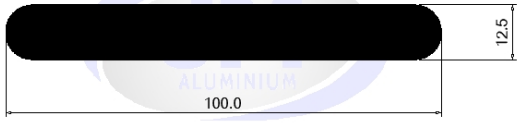
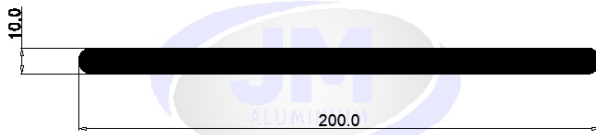
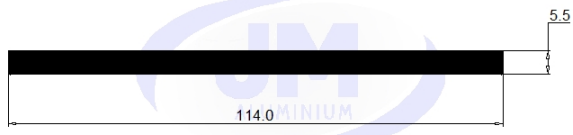
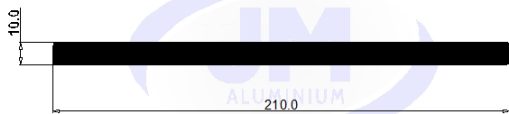
Die No.:12486	Wt.: 3.204 - 3.378 (KG/M)
	
Die No.: 12488	Wt.: 5.037-5.648 (KG/M)
	
Die No.: 12491	Wt.: 1.692 (KG/M)
	
Die No.: 12498	Wt.: 5.454 - 5.867 (KG/M)
	

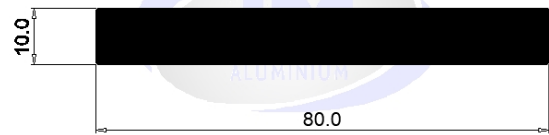
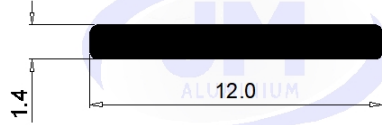
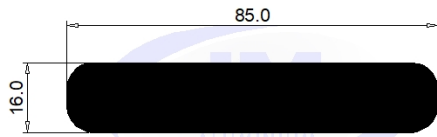
Die No.: 12487	Wt.: 3.158-3.476 (KG/M)
	
Die No.: 12490	Wt.: 2.099-2.220 (KG/M)
	
Die No.: 12496	Wt.:0.045-0.052 (KG/M)
	
Die No.: 12497	Wt.:3.459-3.778 (KG/M)
	

**GEOMETRICAL SHAPES**

**Flat Bar**

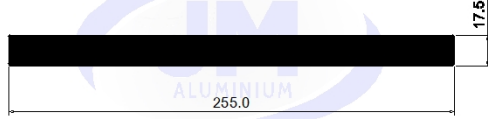
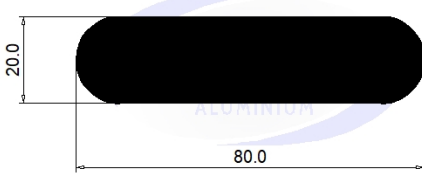
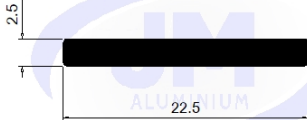
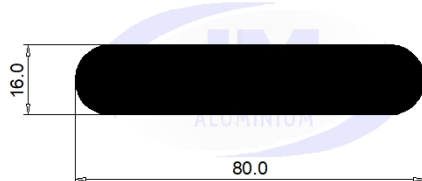
Die No.: 12499	Wt.:11.607 - 12.487 (KG/M)
	
Die No.: 12511	Wt.: 4.026-4.150 (KG/M)
	
Die No.: 12512	Wt.:0.138 - 0.165 (KG/M)
	
Die No.: 12515	Wt.:3.259 - 3.355 (KG/M)
	

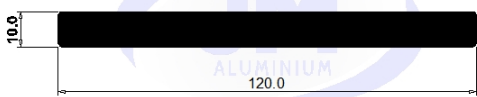
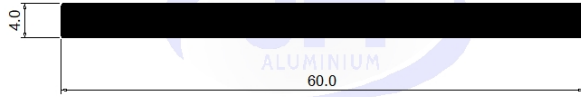
Die No.: 12500	Wt.:3.115 - 3.359 (KG/M)
	
Die No.: 12513	Wt.:0.613 - 0.682 (KG/M)
	
Die No.: 12514	Wt.: 0.619 - 0.730 (KG/M)
