

HVAC

Die No.: 6899

Wt.: 0.885-0.950 (KG/M)

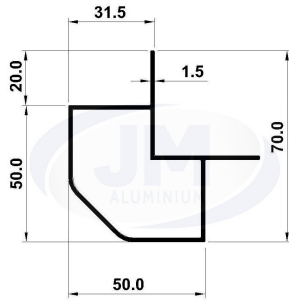

Die No.: 8560

Wt.: 1.420-1.520 (KG/M)

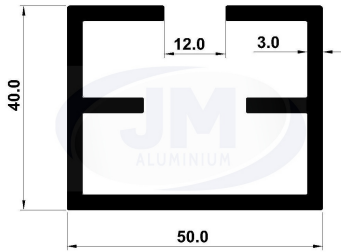

Die No.: 35026

Wt.: 0.570 - 0660 (KG/M)

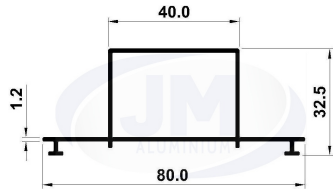

Die No.: 35022

Wt.: 0.690 - 0.800 (KG/M)

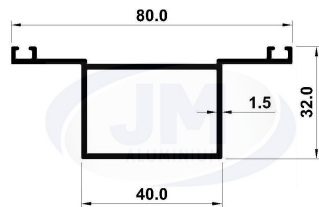

Air Handling Unit

Die No.: 36814

Wt.: 0.868-1.119 (KG/M)

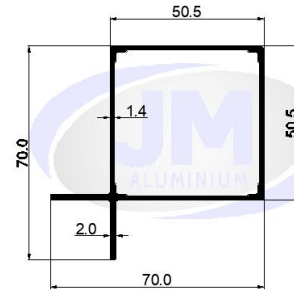

Die No.: 35440

Wt.: 1.100 - 1.130 (KG/M)

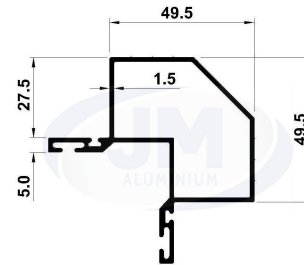

Die No.: 35021

Wt.: 0.290 - 0.350 (KG/M)

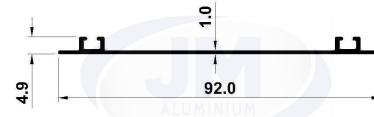

Die No.: 35082

Wt.: 0.750 - 0.860 (KG/M)

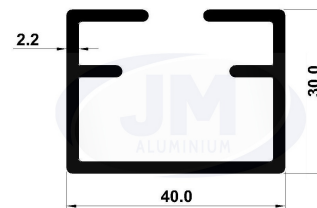

HVAC

Die No.: 35083

Wt.: 1.240 - 1.390 (KG/M)

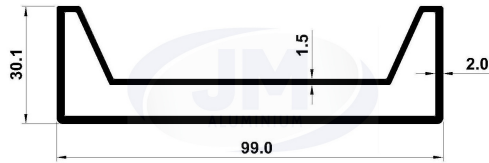

Die No.: 35073

Wt.: 0.240-0.290 (KG/M)

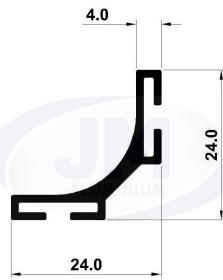

Die No.: 35055

Wt.: 1.300-1.480 (KG/M)

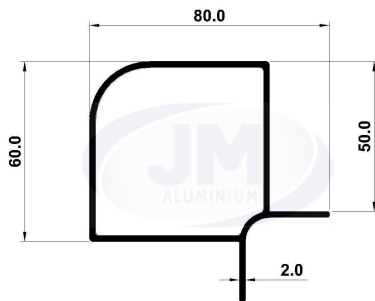

Die No.: 35089

Wt.: 1.770-1.950 (KG/M)

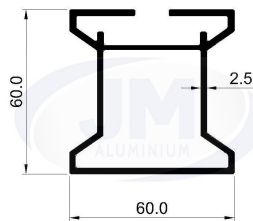

Air Handling Unit

Die No.: 35072

Wt.: 0.650-0.750 (KG/M)

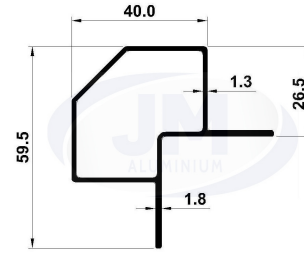

Die No.: 35046

Wt.: 0.850-0.980 (KG/M)

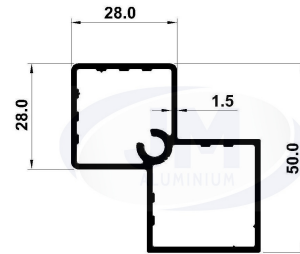

Die No.: 35062

Wt.: 0.450-0.550 (KG/M)

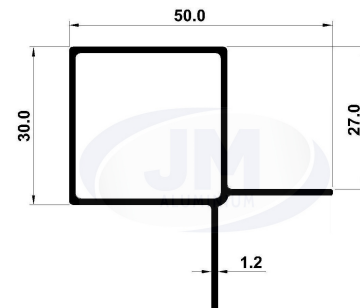

Die No.: 35442

Wt.: 0.120-0.150 (KG/M)

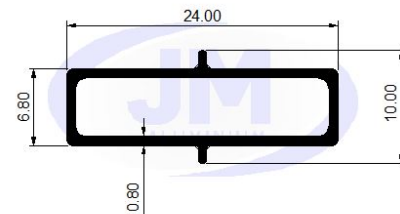

HVAC

Die No.: 35086

Wt.: 1.480 - 1.640 (KG/M)

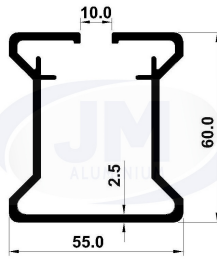

Die No.: 35050

Wt.: 0.640-0.740 (KG/M)

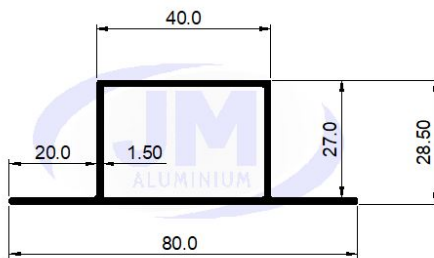

Die No.: 6898

Wt.: 0.785-0.860 (KG/M)

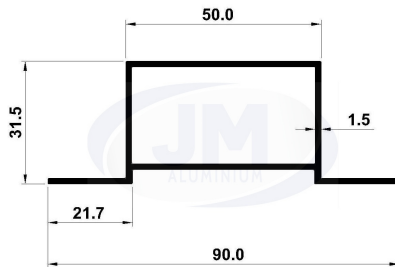

Die No.: 35052

Wt.: 0.680-780 (KG/M)

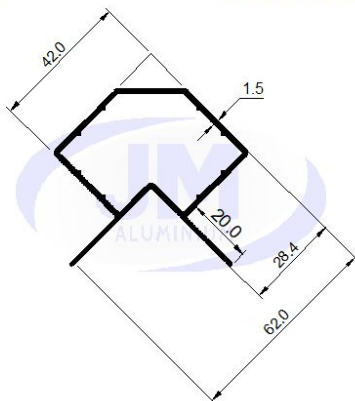

Air Handling Unit

Die No.: 35087

Wt.: 0.930-1.100 (KG/M)

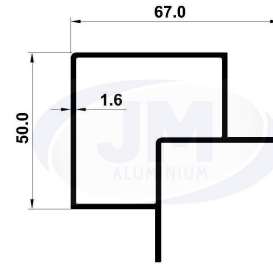

Die No.: 6879

Wt.: 1.345-1.445 (KG/M)

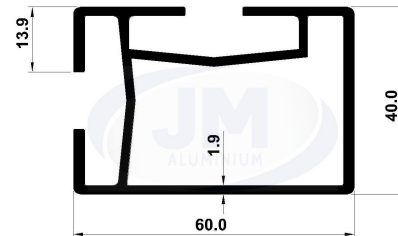

Die No.: 23457

Wt.: 0.290-0.360 (KG/M)

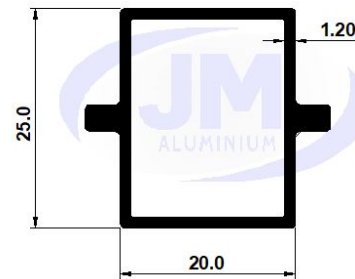

Die No.: 35058

Wt.: 0.670-0.770 (KG/M)

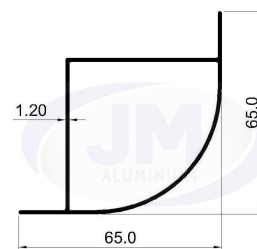

HVAC

Air Handling Unit

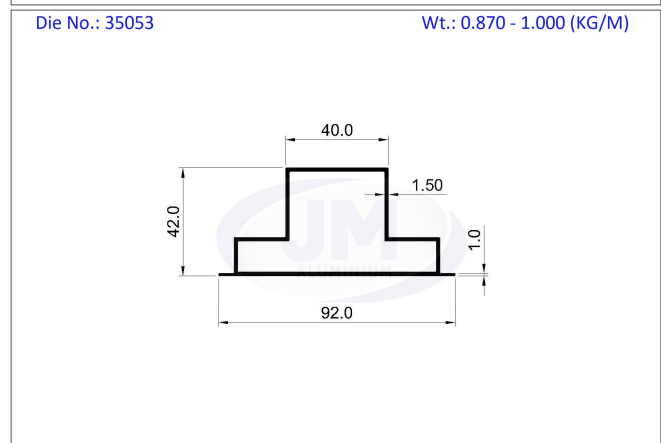
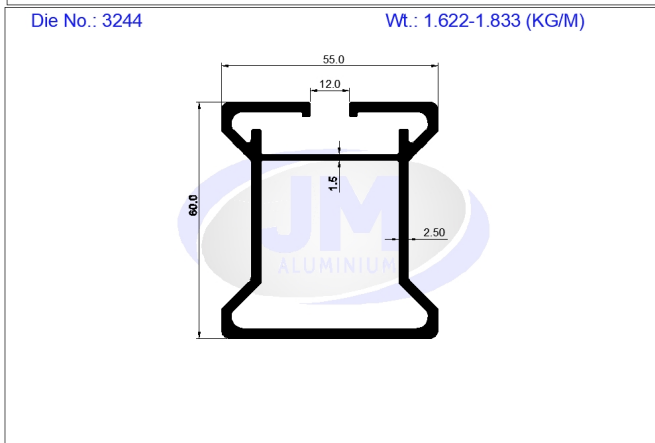
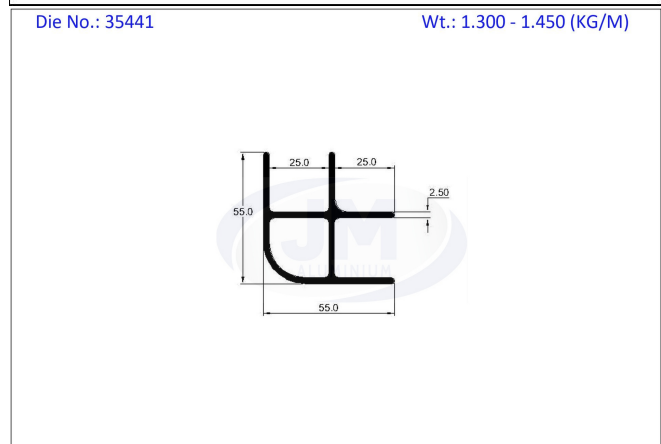
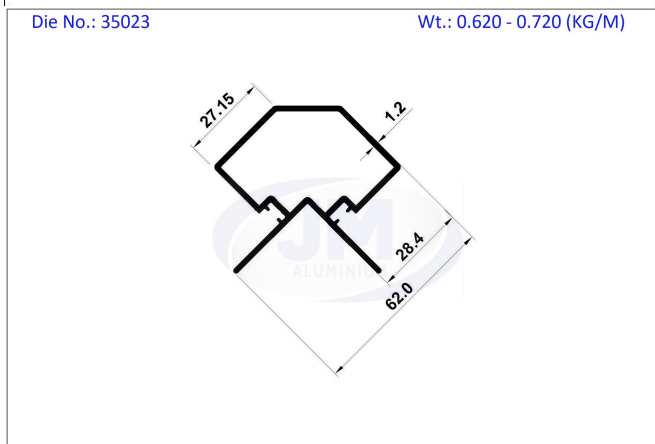
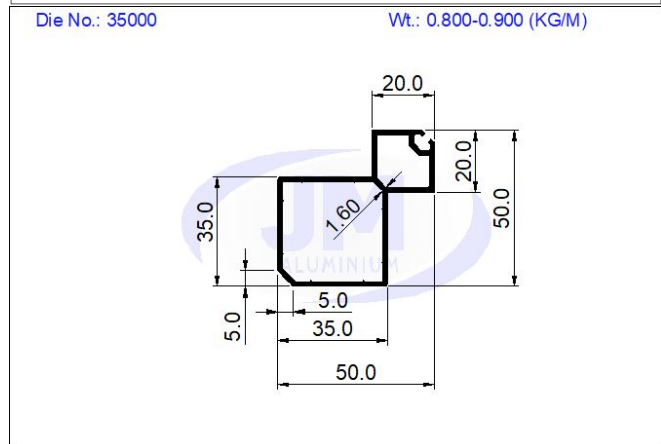
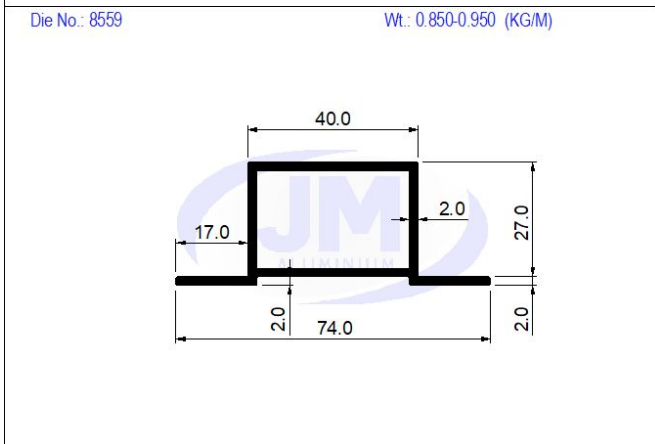
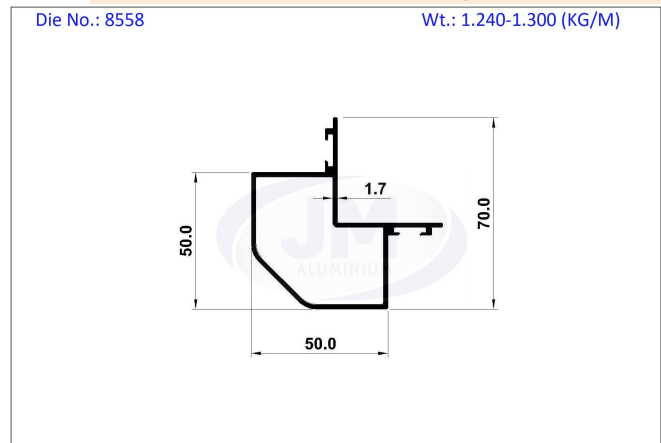
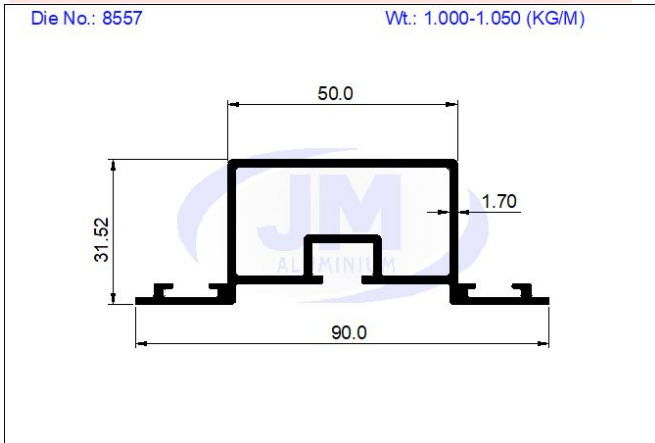

HVAC

Die No.: 37133

Wt.: 1.276 - 1.558 (KG/M)

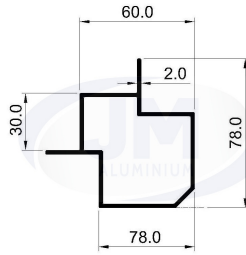

Die No.: 36815

Wt.: 0.923-1.173 (KG/M)

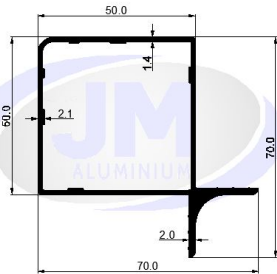

Die No.: 6875

Wt.: 1.000 -1.1000 (KG/M)

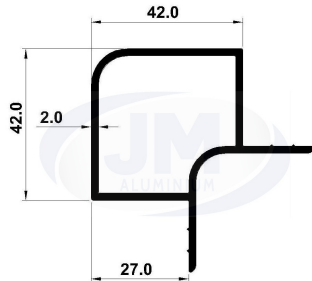

Die No.: 6827

Wt.: 0.600 - 0.700 (KG/M)

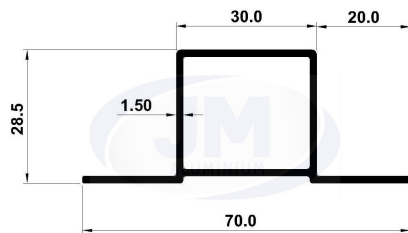

Air Handling Unit

Die No.: 35001

Wt.: 1.200 - 1.340 (KG/M)

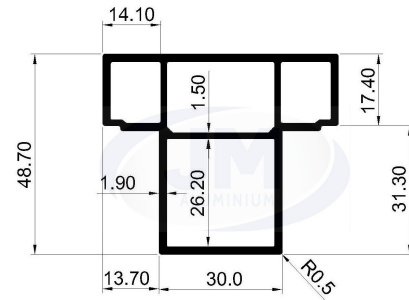

Die No.: 6876

Wt.: 0.800-0.900 (KG/M)

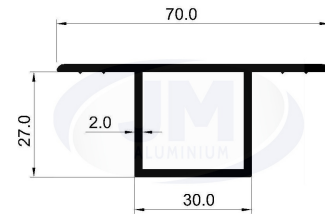

Die No.: 6854

Wt.: 0.340-0.370 (KG/M)

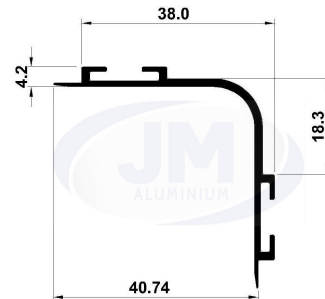

Die No.: 6985

Wt.: 0.650-0.680 (KG/M)

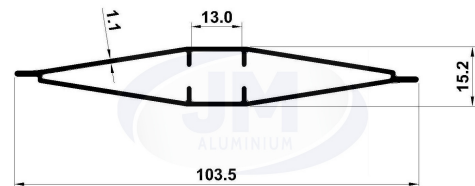

HVAC

Die No.: 6891

Wt.: 1.040-1.120 (KG/M)

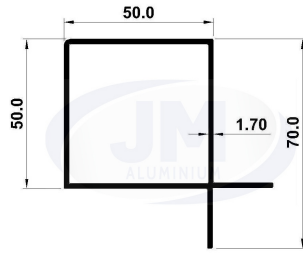

Die No.: 35048

Wt.: 0.480-0.590 (KG/M)

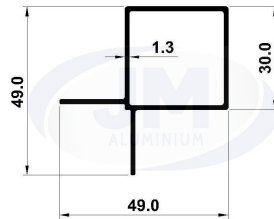

Die No.: 35102

Wt.: 0.900 - 1.000 (KG/M)

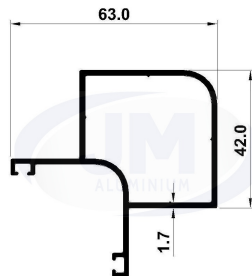

Die No.: 23611

Wt.: 0.915 - 1.055 (KG/M)

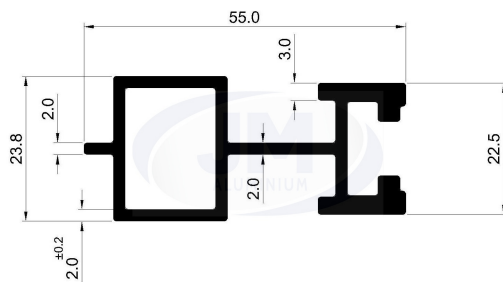

Air Handling Unit

Die No.: 3245

Wt.: 2.640-2.670 (KG/M)

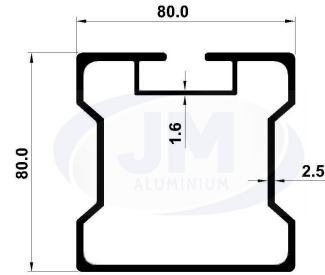

Die No.: 6770

Wt.: 0.935 - 1.000 (KG/M)

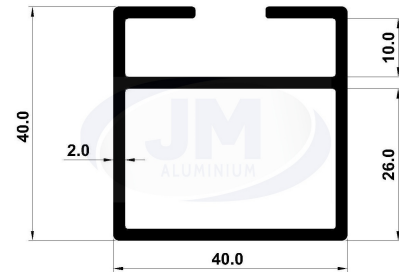

Die No.: 6825

Wt.: 0.575-0.650 (KG/M)

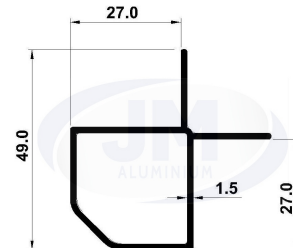

Die No.: 37090

Wt.: 0.957 - 1.079 (KG/M)

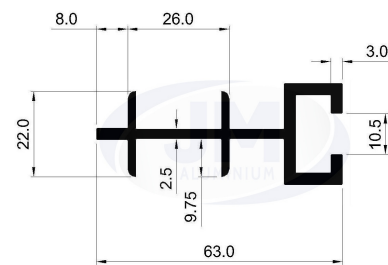

HVAC

Die No.: 35088

Wt.: 0.720 - 0.830 (KG/M)

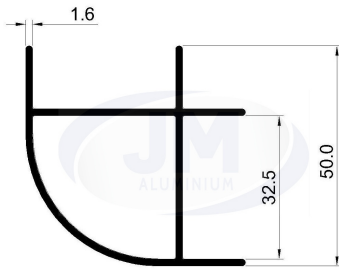

Die No.: 6862

Wt.: 0.870-0.920 (KG/M)

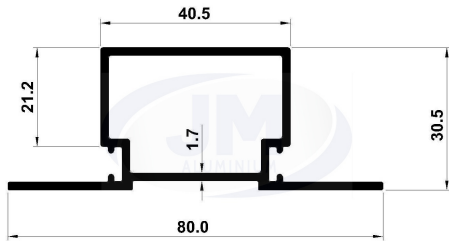

Die No.: 33946

Wt.: 0.145 - 0.195 (KG/M)

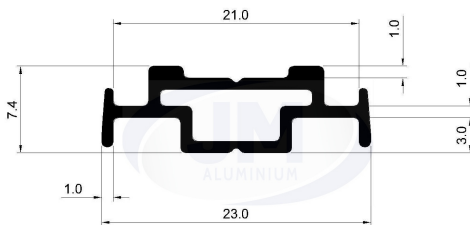

Die No.: 6885

Wt.: 1.100-1.170 (KG/M)

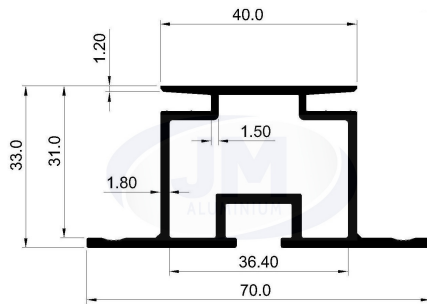

Air Handling Unit

Die No.: 37048

Wt.: 0.680-0.800 (KG/M)

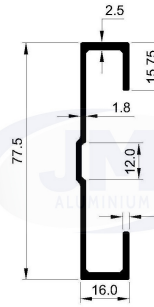

Die No.: 6881

Wt.: 0.930-1.030 (KG/M)

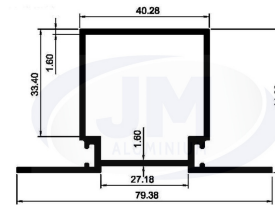

Die No.: 33980

Wt.: 0.294 - 0.374 (KG/M)

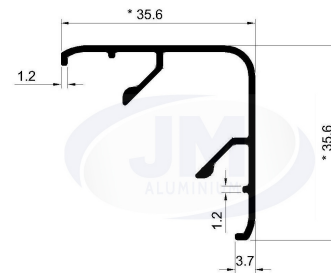

Die No.: 6883

Wt.: 0.650 - 0.700 (KG/M)

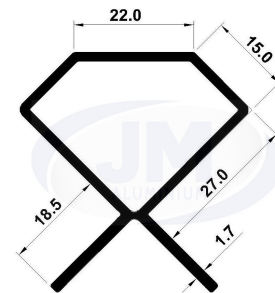

HVAC

Die No.: 6869

Wt.: 0.770-0.870 (KG/M)

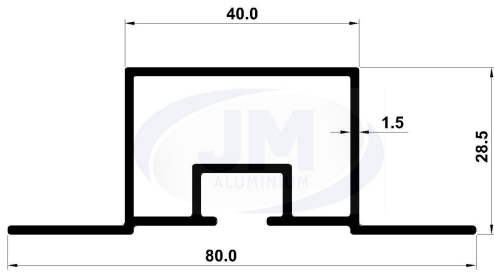

Die No.: 35085

Wt.: 0.570 - 0.660 (KG/M)

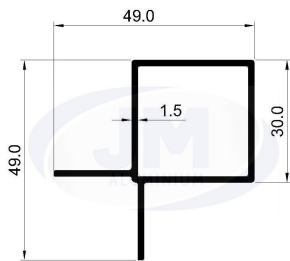

Die No.: 33027

Wt.: 0.330 - 0.400 (KG/M)

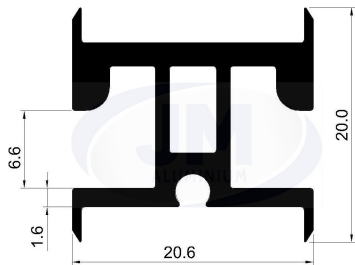

Die No.: 6878

Wt.: 0.855 - 0.930 (KG/M)

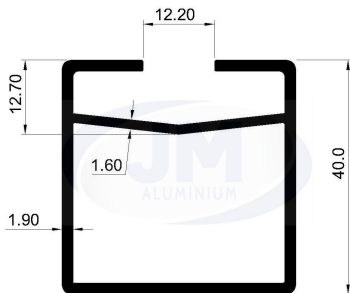

Air Handling Unit

Die No.: 35056

Wt.: 1.110-1.250 (KG/M)

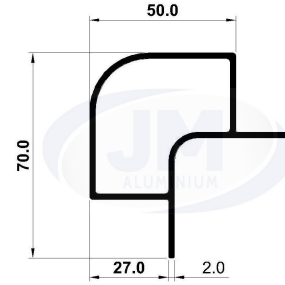

Die No.: 36121

Wt.: 1.00-1.130 (KG/M)

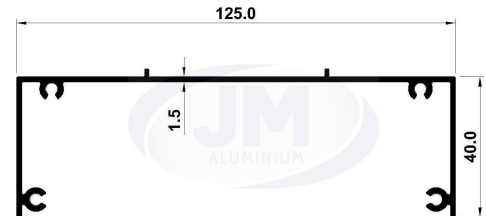

Die No.: 6863

Wt.: 0.940 - 1.020 (KG/M)

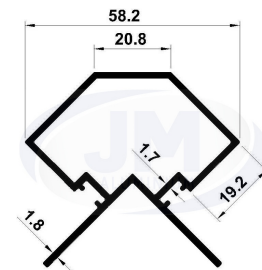

Die No.: 35024

Wt.: 0.725 - 0.825 (KG/M)

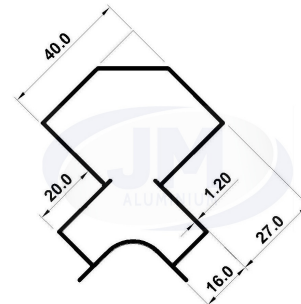

HVAC

Die No.: 35047

Wt.: 1.160-1.300 (KG/M)

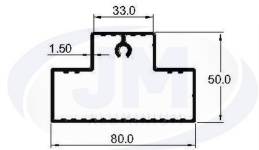

Die No.: 6887

Wt.: 0.640-0.720 (KG/M)

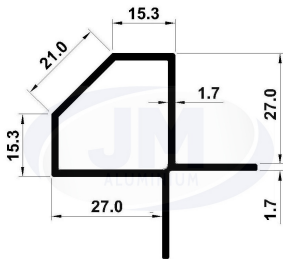

Die No.: 35084

Wt.: 0.810-0.930 (KG/M)



Die No.: 36189

Wt.: 0.170-0.216 (KG/M)

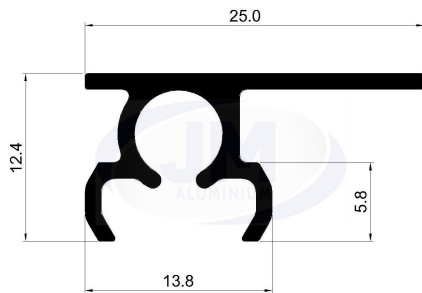

Air Handling Unit

Die No.: 6882

Wt.: 1.080-1.215 (KG/M)

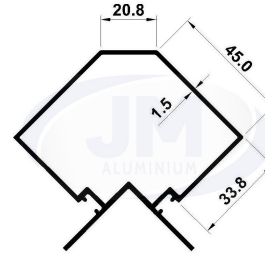

Die No.: 6890

Wt.: 0.970-1.150 (KG/M)

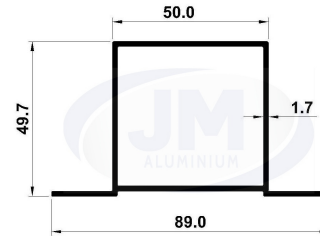

Die No.: 8561

Wt.: 1.130-1.200 (KG/M)

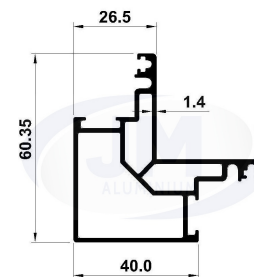

Die No.: 37134

Wt.: 1.000 - 1.220 (KG/M)

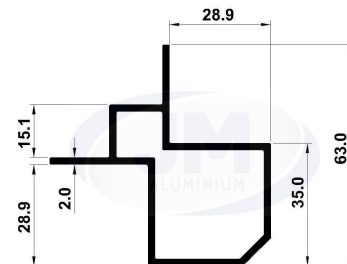

HVAC

Die No.: 6880

Wt.: 2.155 - 2.200 (KG/M)

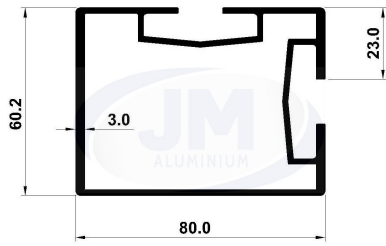

Die No.: 37007

Wt.: 0.340 - 0.410 (KG/M)

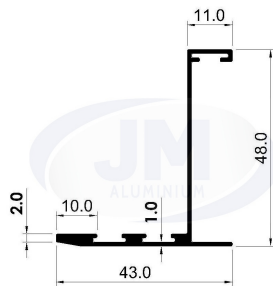

Die No.: 35061

Wt.: 0.460 - 0.550 (KG/M)

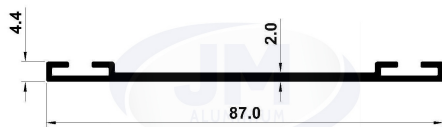

Air Handling Unit

Die No.: 6901

Wt.: 0.260-0.310 (KG/M)

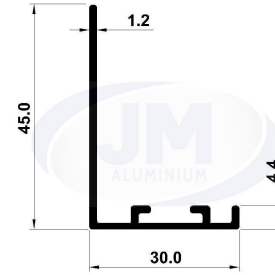

Die No.: 36122

Wt.: 0.720 - 0.820 (KG/M)

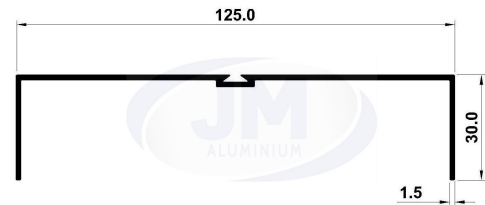

Die No.: 35447

Wt.: 0.780 - 0.900 (KG/M)

